

EL 400

Operational Manual

Digital Readout System

For

Machine Tool



1. Table of Contents





1.	INTRODUCTION	4
2.	DRO SPECIFICATIONS	5
3.	READ BEFORE PROCEEDING	6
4.	GETTING STARTED	7
4.1.	FRONT VIEW	7
4.2.	REAR VIEW	8
4.3.	KEYBOARD LAYOUT.....	9
5.	INSTALLATION	12
5.1.	MOUNTING OPTIONS	12
5.2.	POWER SUPPLY	17
5.3.	ENCODER CONNECTIONS	17
5.4.	POWER UP.....	18
6.	SETUP.....	19
6.1.	SETUP MODE	19
6.2.	PARAMETERS SETTING	20
6.3.	ERROR COMPENSATION.....	22
7.	PRIMARY FUNCTIONS.....	30
7.1.	ABSOLUTE / INCREMENTAL MODE (ABS / INC)	30
7.2.	INCH METRIC DISPLAY (IN / MM).....	30
7.3.	AXIS RESET	30
7.4.	AXIS SET	31
7.5.	HALF FUNCTION	31
7.6.	CALCULATOR.....	32
7.7.	SETTING OF REFERENCE	33
8.	SECONDARY FUNCTIONS	37
8.1.	PRESET	37
8.2.	SUB DATUM MEMORY (SDM).....	38
8.3.	NEAR ZERO WARNING	42
8.4.	CENTER OF CIRCLE	42
8.5.	CENTER OF LINE	43

9.	MACHINE SPECIFIC FUNCTIONS	45
9.1.	MILLING MACHINE SPECIFIC FUNCTIONS	45
9.2.	LATHE MACHINE SPECIFIC FUNCTIONS	61
9.3.	EDM MACHINE SPECIFIC FUNCTIONS	69
10.	AUXILIARY FUNCTIONS	72
10.1.	TOUCH PROBE FUNCTIONS	72
10.2.	SIX OUTPUT FUNCTIONS	77
10.3.	SERIAL COMMUNICATION FUNCTIONS.....	81
11.	TROUBLESHOOTING	83
11.1.	SELF DIAGNOSTICS MODE	83
11.2.	TROUBLESHOOTING GUIDELINES	84
12.	LIST OF DISPLAY TEXT	85
13.	DRO MODELS	88

1. Introduction

Congratulations on purchasing EL 400 series Digital Readout System (DRO) from Electronica Mechatronic Systems. Our DRO incorporates the latest state of the art technology; giving you world class features which help in improving productivity, reducing rejection and at the same time giving ease of operation to user with its ergonomic design.

Some of the key features of EL 400 series DRO are:

-  Adaptability to various types of machines, old and new, simple and complex.
-  Ease of installation.
-  Optional fourth axis gives addition encoder combination possibilities for milling machines.
-  User friendly operations.

 **Note: Please familiarize yourself with the contents of this Operators manual to benefit from all features provided by EL 400 DRO.**

 **Electronica Mechatronic Systems (I) Pvt. Ltd. Reserves the right to change specifications without prior notice.**

2. DRO Specifications

Mains Supply	90.....265 VAC 50/60 Hz
Fuse Rating	800mA Slow Blow 20mm
Power Consumption	20 Watts Maximum
Storage Temperature	-20°C to 70°C
Operating Temperature	0°C to 50°C
Relative Humidity	20% To 85% Non-Condensing
Dimensions (mm) (*excluding earth stud)	155 X 270 X 80 Height X Width X *Depth
Net Weight	Approx 1.5 Kg
Encoder Input	RS422
Encoder Connector Type	9-Pin D-Type Female
Auxiliary Connectors	15-Pin D-Type Female For Auxiliary Output (Optional) Encoder Jack Plug connector for Probe input(Optional) USB B type connector (for service only)
Encoder Resolution Supported	0.1/0.2/0.5/1/2/5/10/20/50 Micron
Display	7 Digits with +/- indicator 7 Segment LED
Quantization Error	+/- 1 Digit
Standard Compliance	EMC and Low Voltage Compliance BS EN 61326 RoHS



ISO 9001:2008
COMPANY

3. Read Before Proceeding

- ☞ The EL 400 DRO is sophisticated electronic equipment and should be carefully handled to avoid any damage.
- ☞ The rated supply to DRO should be within specified limits and should not be exceeded under any circumstances. Doing so may cause irreversible damage to DRO.
- ☞ DRO should be opened by authorized person only. Otherwise it will invalidate the warranty of the unit.
- ☞ Equipotential Point (Ground) should be provided to avoid erratic operations of DRO.
- ☞ Cable routing of DRO and encoders should not be routed through or nearby high capacity switching/inductive load or where it can cause danger.
- ☞ EL 400 DRO is standard compliant with
 - ☞ EMC Directive EN61326 Standard 61326-4-2, 61326-4-4, 61326-4-11, 61326-4-5, CISPR 16-1 and 16-2.
 - ☞ RoHS compliant.
- ☞ **Warranty will be considered void if and not limited to**
 - ☞ Failing to meet manufacturers specified supply conditions.
 - ☞ Abusive handling.
 - ☞ Environmental conditions outside of Manufacturers specifications.
 - ☞ Manipulation, tampering of electronics.
 - ☞ Replacement of original parts with other parts than specified by manufacturer.
 - ☞ Used with encoders other than those supplied by the manufacturer.
- ☞ **Disposal**

At the end of its life the EL 400 DRO systems should be disposed of in a safe and environmentally sympathetic manner as applicable to local legislation. The casework and other components may be suitable for recycling. **DO NOT BURN.**

4. Getting Started

4.1. Front View

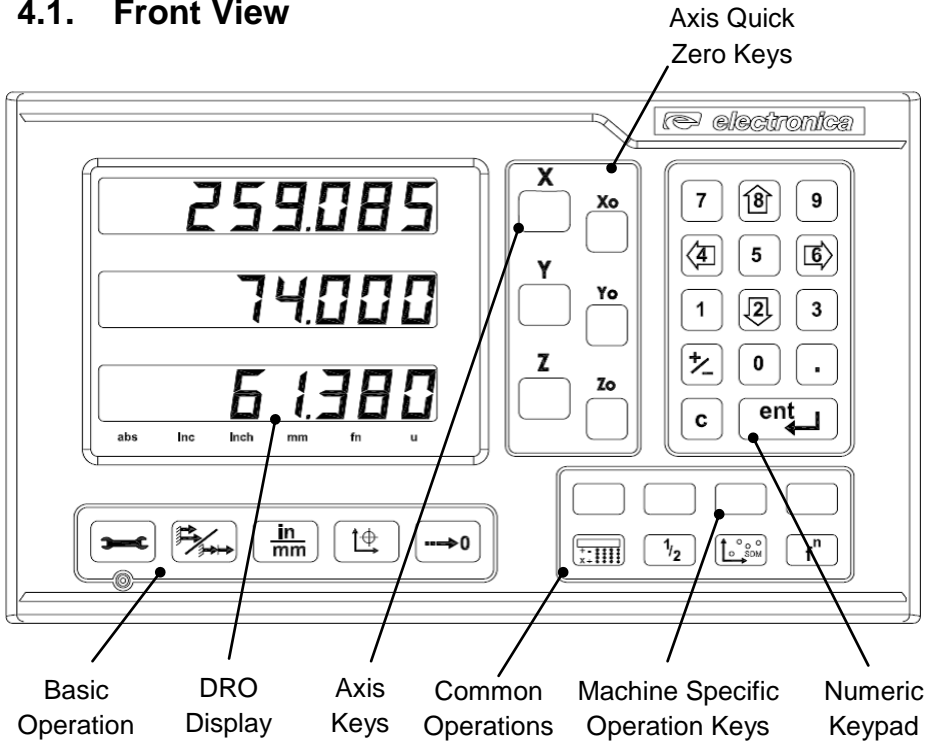

Note: In 4 Axes model, press Z followed by Z0 to toggle between Z and U axis display and 'u' LED glows.

4.1.1. Machine Specific Operation Keys:



Milling machine functions

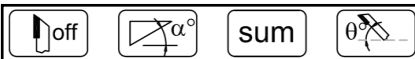

Lathe machine functions.

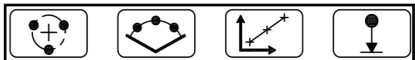

EDM machine functions.

Note: Simple DRO doesn't have machine specific functions.



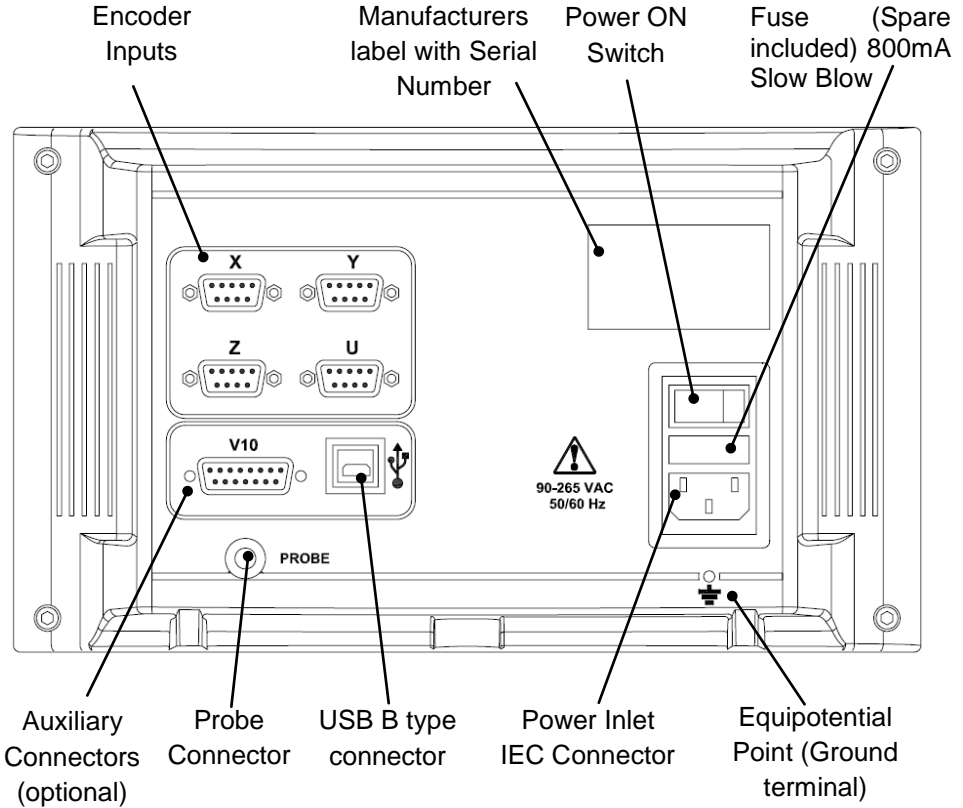





4.2. Rear View

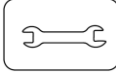
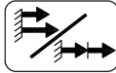
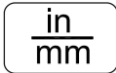
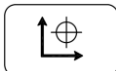
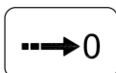



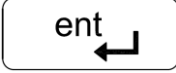





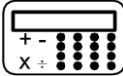
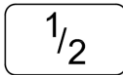
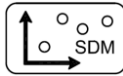
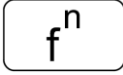

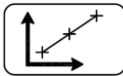
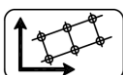

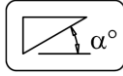



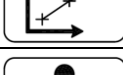
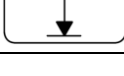



Note:

1. This rear view is for 4-Axis EL 400 DRO.
2. For lathe machine, connect Z axis at 'Y' and 'Z' at Z axis.

4.3. Keyboard layout

Symbols	Description	
	Setup	Setup and mode keys
	ABS / INC	
	Inch / mm	
	Reference	
	Preset	
	Numeric Keys	NUMERIC KEYBOARD
	Toggle Sign	
	Decimal Entry	
	Enter	
	Cancel	
	Toggle Keys	
	Navigation Keys	

	Calculator Function	COMMON OPERATIONS
	Half Function	
	SDM Function	
	Function Key	
	Bolt-Hole (PCD) Function	MILLING SPECIFIC FUNCTIONS
	Arc Contouring Function	
	Angle Hole Function	
	Grid Hole Function	
	Tool Offsets	LATHE SPECIFIC FUNCTIONS
	Taper Calculation	
	Summing Function	
	Vectoring Function	
	Bolt-Hole (PCD) Function	EDM SPECIFIC FUNCTIONS
	Arc Bolt-Hole Function	
	Angle hole Function	
	PSD (Pre-Set Depth) Function	

  	Axes keys for Simple, Mill and EDM version.	AXES KEYS
  	Axes Quick Reset keys for Simple, Mill and EDM version.	
  	Axes keys for Lathe version.	
  	Axes Quick Reset keys for Lathe version.	

5. Installation

5.1. Mounting Options

Following are the possible options for mounting of EL 400 DRO.

 Single Arm DRO mount (Code No. 0114-03-0110)

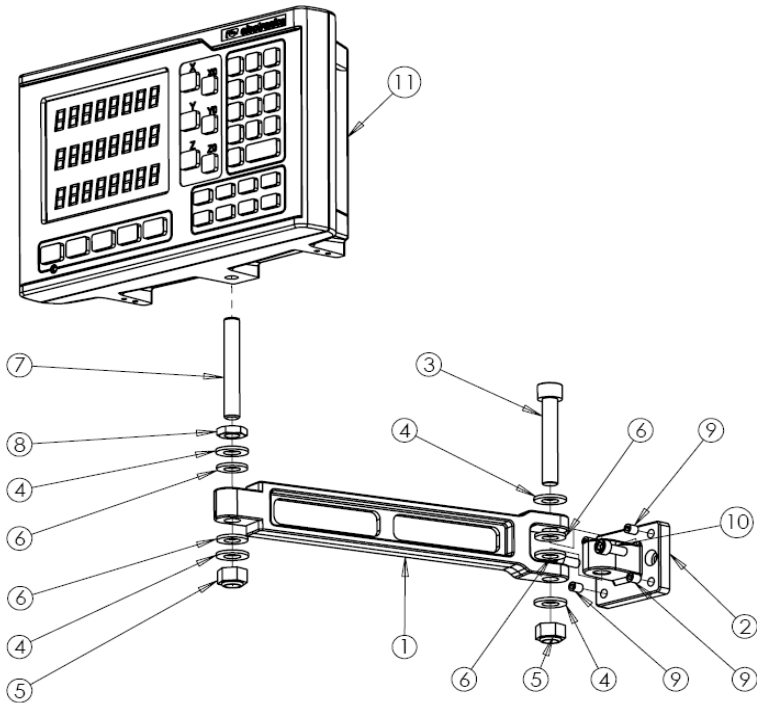

No.	Description	Qty.
1	Fork arm	1
2	Machine mounting Bracket	1
3	M10 X 60mm Allen head Screw	1
4	M10 punched washer	4
5	M10 Nylock nut	2
6	M10 Nylon spacer	4

No.	Description	Qty.
7	M10 X 75mm Stud	1
8	M10 Lock nut	1
9	M6 X 8mm Allen grub screw	4
10	M6 X 16mm Allen head screw	2
11	EL 400 Series DRO	1

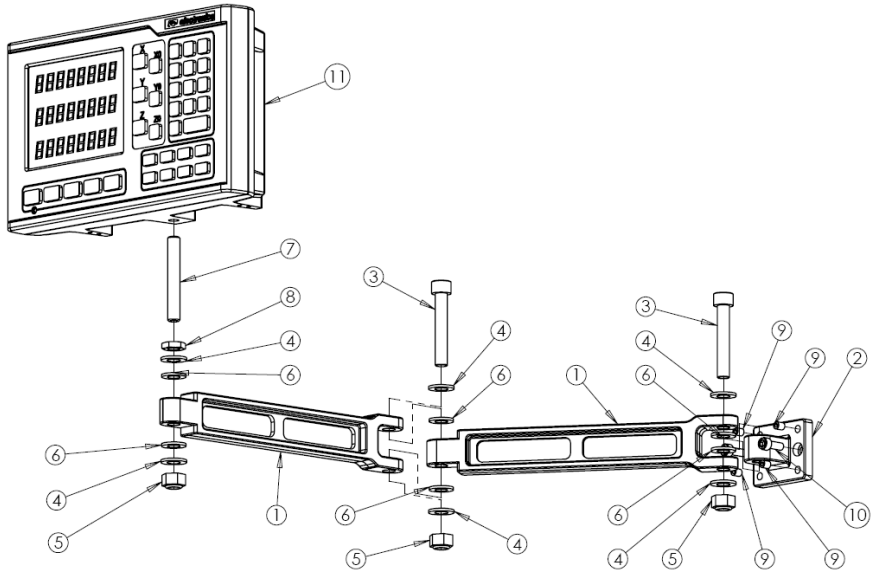
Double Arm DRO mount (Code No. 0114-03-0120)

No.	Description	Qty.
1	Fork arm	2
2	Machine mounting Bracket	1
3	M10 X 60mm Allen head Screw	2
4	M10 punched washer	6
5	M10 Nylock nut	3
6	M10 Nylon spacer	6

No.	Description	Qty.
7	M10 X 75mm Stud	1
8	M10 Lock nut	1
9	M6 X 8mm Allen grub screw	4
10	M6 X 16mm Allen head screw	2
11	EL 400 Series DRO	1

DRO Lathe mount stand (Code No. 0114-03-0140)

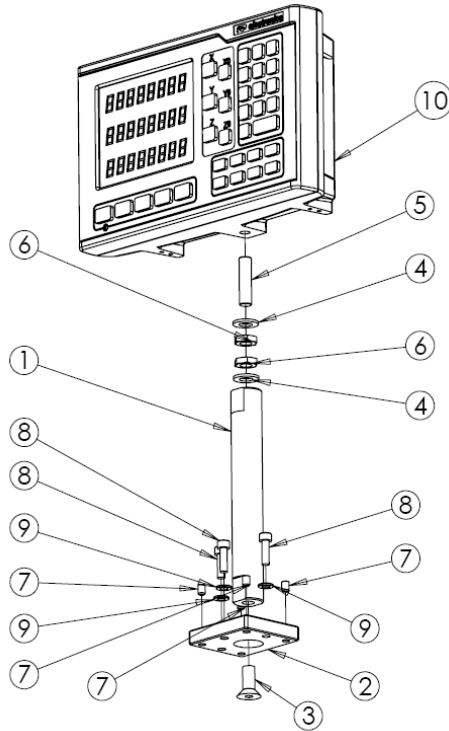

No.	Description	Qty.
1	Bar for Lathe stand	1
2	Base plate for Lathe Stand	1
3	M10 X 20mm CSK Allen screw	1
4	M10 punched washer	2
5	M10 X 40mm Full Threaded stud	1

No.	Description	Qty.
6	M10 Lock nut	2
7	M6 X 8mm Allen grub screw	4
8	M6 X 20mm Allen head screw	3
9	M6 punched washer	3
10	EL 400 Series DRO	1

 **DRO Lathe mount stand with Single ARM (Code No. 0114-03-0150)**

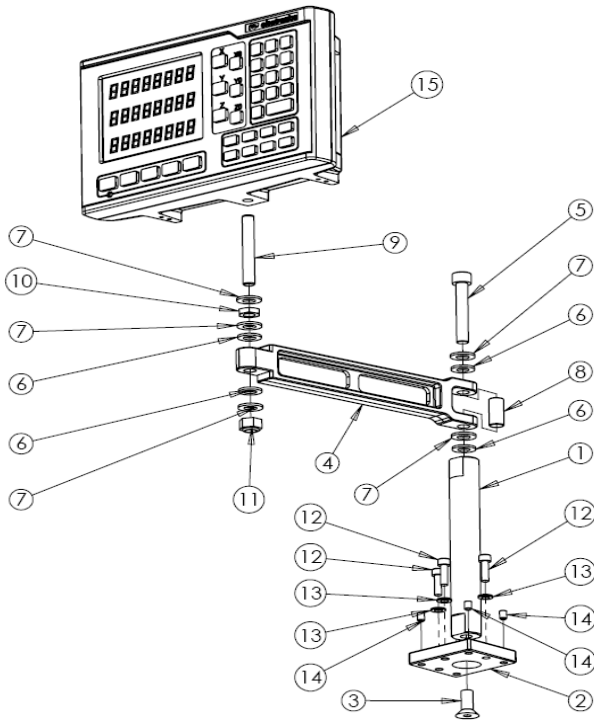

No.	Description	Qty.
1	Bar for Lathe stand	1
2	Base plate for Lathe stand	1
3	M10 X 20mm CSK Allen screw	1
4	Fork Arm	1
5	M10 X 60mm Allen head screw	1
6	M10 Nylon Spacer	4
7	M10 punched washer	5
8	Spacer between fork	1

No.	Description	Qty.
9	M10 X 75mm Stud	1
10	M10 lock Nut	1
11	M10 Nylock nut	1
12	M6 X 20mm Allen head screw	3
13	M6 punched washer	3
14	M6 X 8 mm Allen grub screw	4
15	EL 400 Series DRO	1

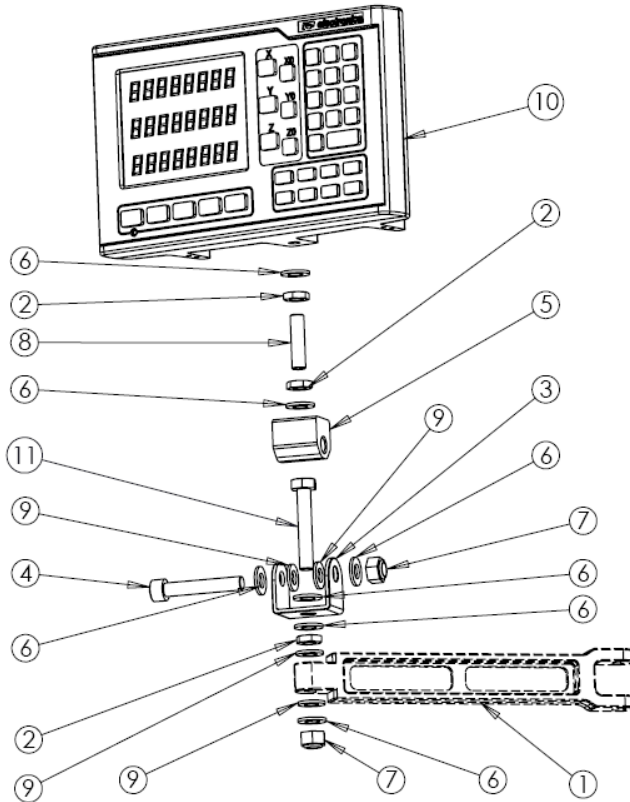
DRO Swivel mount (Code No. 0114-03-0130)

No.	Description	Qty.
1	Fork arm	1
2	M10 Lock nut	3
3	Swivel bracket	1
4	M10 X 60mm Allen head screw	1
5	Swiveling block	1
6	M10 punched washer	7

No.	Description	Qty.
7	M10 Nylock nut	2
8	M10 X 40mm Full Threaded stud	1
9	M10 Nylon spacer	4
10	EL 400 Series DRO	1
11	Hexagon Bolt M10 X 60mm	1

5.2. Power Supply

The EL 400 DRO series uses a Switch mode power supply inside which covers the universal power input range i.e. 90VAC to 265VAC / 50 to 60 Hz. Ensure the input power is within the specifications before powering the unit.

The power supply to the DRO should not be given from the same source as that of any high capacity switching / inductive loads to avoid interference.

Ensure proper equipotential point (Ground) connection is provided to the DRO to avoid any erratic operations.

5.3. Encoder Connections

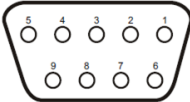
	Pin Number	Output Signal
	1	ABS ^{*1}
	2	/ABS
	3	VCC (+5V)
	4	Shield ^{*2}
	5	GND (0V)
	6	Phase A
	7	Phase /A
	8	Phase /B
9	Phase B	

 **Note:**

*1 - ABS is Reference Mark.

*2 – Ensure proper shielding of the encoder cables for proper functioning of the encoder and the DRO.

Encoder Cable should be properly routed as per manufacturers' guidelines. Cable should not be routed near any inductive loads to avoid electrical noise interference. It should be routed away from the machine moving parts to avoid any damage.

5.4. Power UP

Switch ON the power switch located on the back of the DRO. The DRO will display the power UP message momentarily as shown below

 Displays the DRO model

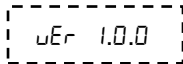
 Displays the current Software version

Power up message can be bypassed by pressing the  key.

6. Setup

6.1. Setup Mode

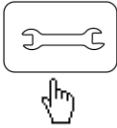

Pressing setup key will open Setup menu on DRO

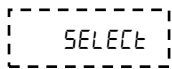

Select Axis

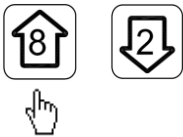

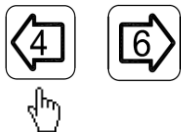

With the help of navigation keys you can choose the parameter as shown in table2.









With the help of navigation keys left / right you can choose the settings of each parameter.

6.2. Parameters Setting

Following parameters are available for setting

Display	Parameter	Setting options
<i>L inEAR</i> <i>AngULAr</i>	Counting mode	Linear / Angular
<i>SC 5.0</i>	Measuring system resolution* ⁶	0.1/0.2/0.5/1/2/5/10/20/50 Micron
<i>dP 5.0</i>	Display resolution* ⁵ (Linear)	0.1/0.2/0.5/1/2/5/10/20/50 Micron
<i>dd.n̄n̄</i> <i>dd.n̄n̄.SS</i> <i>dd.dEE</i>	Display resolution* ⁶ (Angular)	Degrees-Minutes/ Degrees-Minutes-Seconds / Degrees-Decimal
<i>rAd</i> <i>d iA</i>	Measurement mode* ⁶ (Linear)	Radial / Diametric
<i>LEFt</i> <i>r iGht</i>	Direction	Left / Right
<i>CAL ib</i>	Error Comp. (Section 6.3)	Press  for error compensation
<i>EnF oFF</i> <i>EnF on</i>	Measuring system error message * ²	On / Off
<i>AUH Fn</i>	Auxiliary function* ¹ (Section 10)	Press  for Auxiliary Function Menu
<i>SEr iAL</i> <i>SEr Con</i>	Data transmission RS232 options mode	Serial or Serial Continuous
<i>dro F</i> <i>dro t</i>	Touch probe function* ¹ (Section 10.1)	DRO F / DRO T type
<i>Prb dLY</i>	Probe Delay* ¹ (Section 10.1.1)	1 to 60 seconds
<i>PULSE</i> <i>Cont</i>	Six O/P signal* ¹ (Section 10.2)	Pulse / Continuous
<i>TAPERon</i>	Taper On* ¹ (Section 9.2.2)	X / Y / Z axis

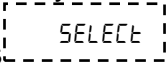
Ad it ion	Axes summing* ¹ (Section 9.2.3)	X – Z' axis / Z – Z' axis
LoC OFF LoC ON	Keypad Lock* ³	On / Off
SLEEP t	Sleep mode* ⁴	Press  to set Sleep time, from 0 to 120 minutes
SAU CHG	Store setting	Press  to store changed settings.
rSt aEn	Reset* ⁶	Press  to Restore default settings
aEn nOd	OEM mode	Password protected OEM mode
End	End	Press  to exit from setup

When you press  key once again, you return to the set up mode. Display shows . Press  to exit.

Note:

*1 - These parameters are specific to the models as mentioned in the given Section.

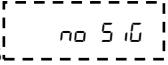
*2 - The measuring system error message is displayed when the encoder cable gets disconnected from the DRO or it is damaged along the length. The error message is displayed on corresponding axis display as .

*3 - With keypad lock, all key operations except set up are locked. This helps in not losing the datum point because of wrong reset operation.

*4 - The display is switched off for the time in sleep timer, with any key operation the display gets 'ON'.

*5 - The resolution of the display can be set coarser than of the measuring system used.

*6 – It is applicable for individual axis

6.3. Error compensation

Error compensation is required during DRO installation as there are errors due to ball screw pitch error or deflection & tilting of axes. The error can be also because of measuring system.

This error can either be linear or non-linear. These errors can be determined either with the help of reference measuring system or a slip gauge.

6.3.1. Error compensation for linear Axis

6.3.1.1. Linear Error Compensation (LEC)

Linear error compensation can be applied, if the results of the comparison with a reference standard show a linear deviation over the whole measuring length. In this case the error can be compensated by the calculation of a single correction factor.

Navigation to Calibration Menu

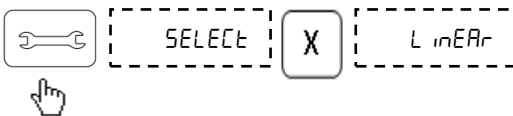

Selection of axis for error compensation.

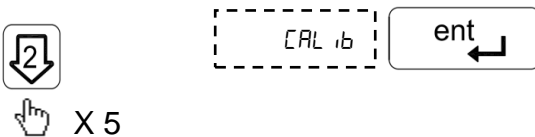

Linear Error Compensation

LEC

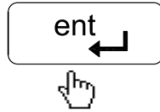

Select Linear Error Compensation (LEC) menu.

d SP_{UAL}

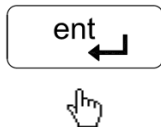

100.325

Press Enter for display

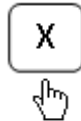
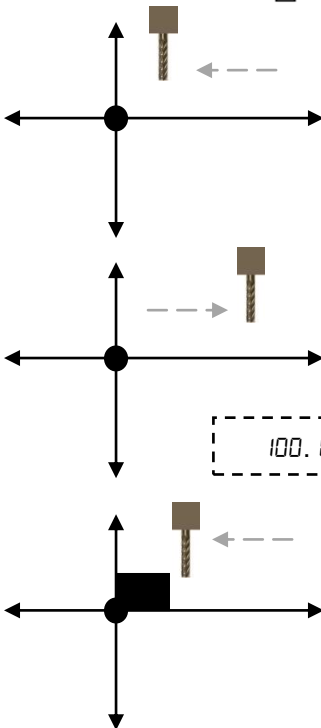

Set the machine at datum point (starting point) and press the axis key to reset the axis.

Move the axis away from datum point to put the slip gauge at datum point.

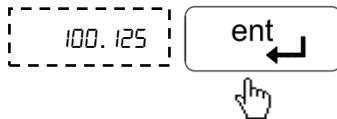

100.125

Move the axis to touch the slip gauge. The display value is the measured length of the slip gauge

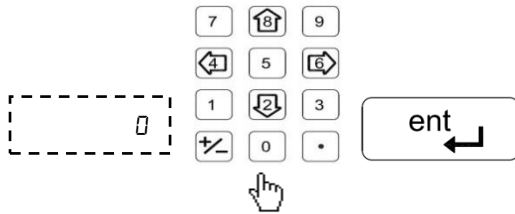

Input the reference value of slip gauge in **millimeter (mm)** and press .

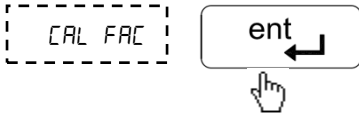

Now the DRO shows the calibration factor. Press Enter key to read the calibration factor.

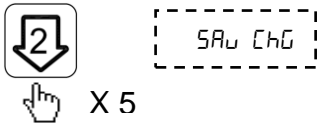

Select the save changes mode with the help of down arrow key. Confirm with the Enter key.

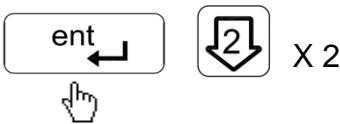

Using down arrow key exit to display screen. Press enter key to exit from setup mode.

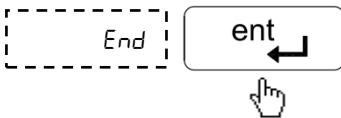

Now the linear error compensation is stored and applied.

6.3.1.2. Segmented Error Compensation (SLEC)

Segmented Linear Error Compensation (SLEC) is used when the results of the comparison with a reference standard shows non-linear error. In SLEC the entire axis travel is divided into as many as 99 user defined segments. The error in each segment is compensated with a single correction factor. Each correction point is measured with respect to the starting point. This starting point is usually set close to the end of the scale. This starting point can coincide with the absolute datum point.

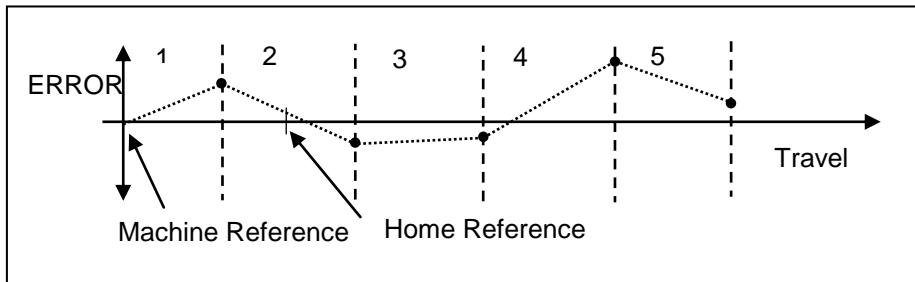

6.3.1.2.1. Auto Mode

Select the Calibration menu under setup as per [Section 6.3.1.1](#) then select SLEC option as **follows**:



Set the machine slide near encoder reference and then select SLEC menu.

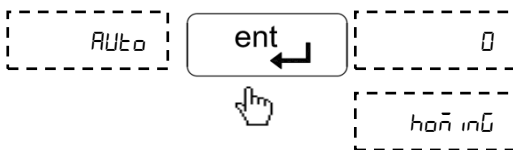

Last digit of axis display is blinking which indicates that this axis is ready for sensing the reference mark.

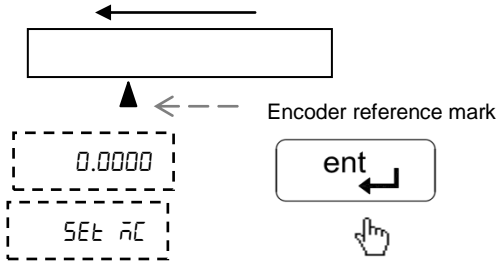

Move the machine to cross reference mark and reach the start point of the first segment.
Press Enter key.

This will set the machine reference at the start of first segment. For more information on machine reference see [Section 7.7.2](#).

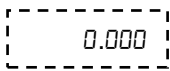

Now reach the end of the first segment.
Press the key.

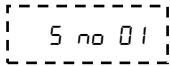

(Input the length of the segment as measured by standard.) Repeat this step for all segments.

After completing all segments navigate using

key to save changes and press .

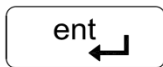

X 5

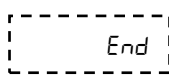
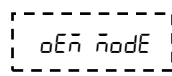
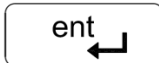
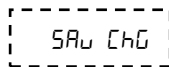

Press key to exit the setup mode. This indicates that error compensation is complete.

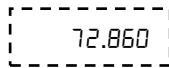
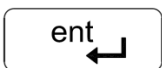

6.3.1.2.2. Edit Mode

Edit mode allows user to check and edit the error compensation values for each segment after setting up in Auto mode.

Select Segmented Linear Error Compensation (SLEC) menu as per [Section 6.3.1.2.1](#)



Press  key to select edit mode.

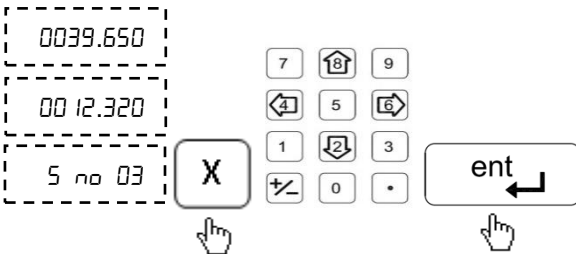

Pressing axis key select the axis for which the value is to be edited. Using numeric keypad enter the correct value.

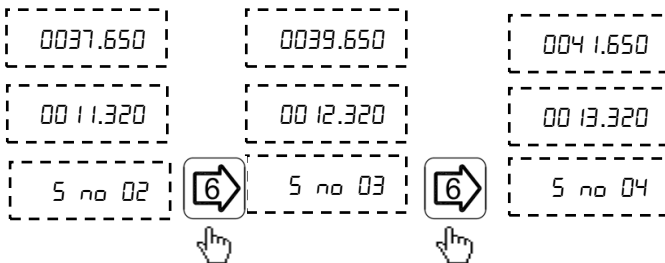

Using left and right keys user can go through all segments.

After completing editing, navigate to mode with down arrow key and press enter. Then exit by pressing enter again.

 **Note: If segmented error compensation has been defined, no error compensation will be applied until the reference mark is crossed.**

6.3.2. Error Compensation for Angular Axis

For error compensation of angular axis measurement, select the angular counting mode parameter in setup as mentioned in [Section 6.2](#). With down arrow key select error compensation menu.

6.3.2.1. 360° Rotation Method

Select Angular mode for measurement in setup and navigate to Calibration menu as per [Section 6.3.1.1](#)

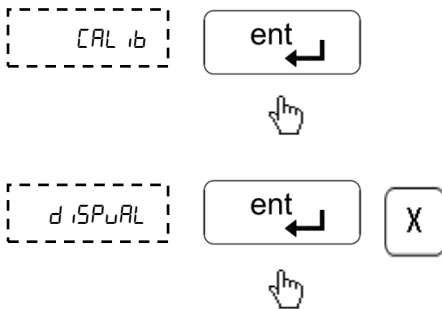

Enter calibration menu.

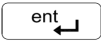
Press  to display value. Set the machine at datum point (Stationary point) and press axis key to reset the axis.

Move the machine to complete one rotation of table. It is highly recommended to place a marker so as to complete one round accurately.

Enter value of 360° in terms of seconds i.e. 1296000.

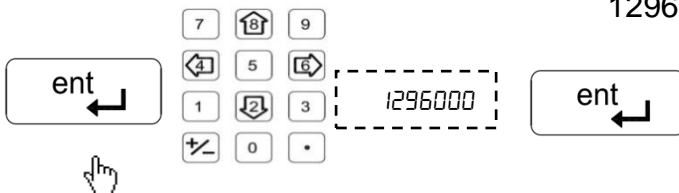

Save changes and exit to counting screen.

6.3.2.2. Pulses per Revolution (PPR) Method

Enter calibration menu as per [Section 6.3.1.1](#)

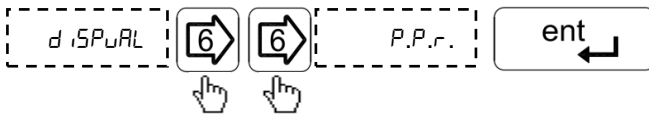

Select PPR menu.

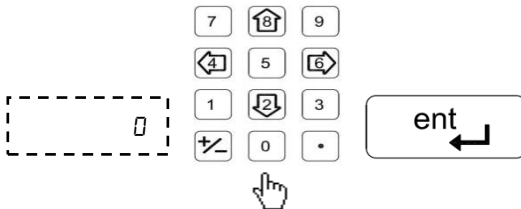

Enter PPR value of encoder and press enter.

Save changes and exit to counting screen.

7. Primary functions

7.1. Absolute / Incremental mode (ABS / INC)

The  key toggles between the Absolute / Incremental position display.

Absolute mode displays the positions of all axes from a fixed datum.

The Incremental mode displays each position relative to the last position. This is also known as point to point use.

The LED indicates the current selection of mode.

 **Note: At the beginning of each working session, set the datum in Absolute Mode, and then switch the DRO to Incremental Mode. By using the DRO in this way, you can return the machine to its absolute datum at any time, simply by switching back to Absolute Mode.**

7.2. Inch Metric Display (In / mm)



The  key toggles between the Inch units (in) or the millimeter units (mm).

The LEDs indicate the current mode of display.

7.3. Axis Reset

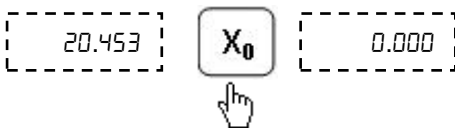
This function is used to Zero the axis.





Pressing axis reset key (, , ) will reset the respective axis.

When axis reset function is activated in ABS mode, it will redefine the datum of the travel, and then it is not possible to restore the old datum.

7.4. Axis Set

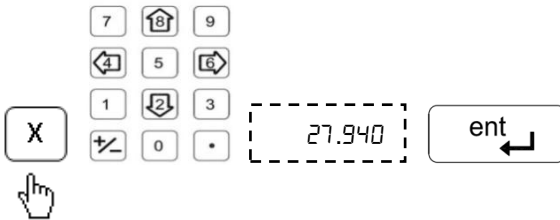
This function is used to set the axis with a known value.



Select axis key. Enter the numeric value to preset the selected axis. Confirm with  key.

Incorrect numeric entries can be cancelled one by one using .

Using this in ABS mode will alter the datum of that axis, so it will not be possible restore the old datum.

7.5. Half Function

This function is used to find the center of a work piece by halving the displayed distance on the selected axis.

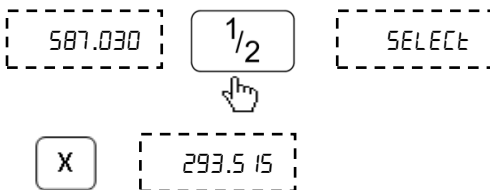

Press  key followed by axis key will half the value of axis display.

It is recommended to use this function in INC mode. If you press this key in ABS mode, it will change the datum point of the axis.

7.6. Calculator

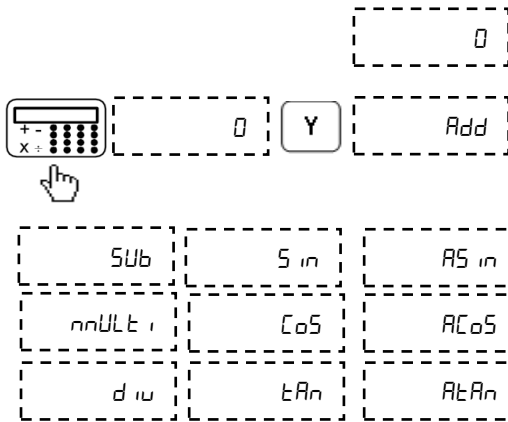

Press **Y** key to select the mathematical functions from the list shown.

7.6.1. Illustrated Example

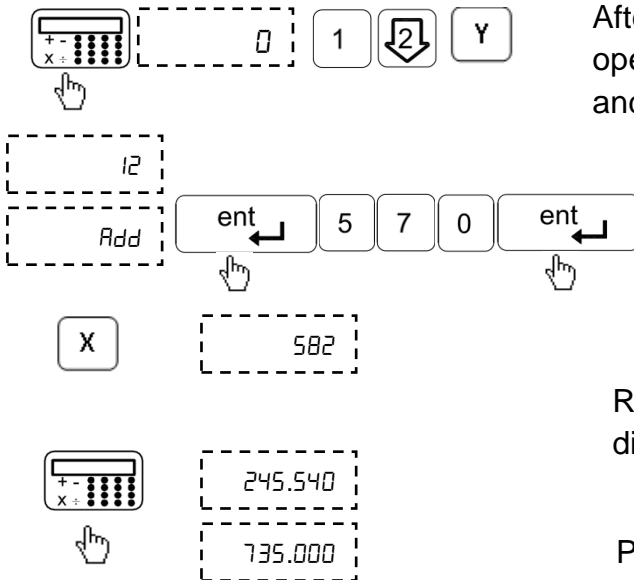

After selecting desired operation, enter values and press enter.

Result will be displayed on X axis.

Press calculator key again to exit calculator mode.

7.7. Setting of reference

This function allows user to set a machine zero point. With this machine zero point users can restore the work coordinates even if the machine is moved when the DRO is in OFF condition. Generally each encoder has reference marks present at every specified interval. These reference marks are used to recall the same datum point every time.

This function works only in ABS mode. If tried to use in INC mode, the DRO is automatically forced to ABS mode and then the function executes.

There are two Positions which can be set as datum point (Home function)

- Reference point of measuring system.
- Machine reference mark.

7.7.1. Reference Point

In this function, the Datum is set at the reference mark on the encoder.

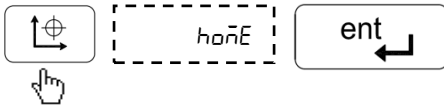

Press  key and select 'Home' mode by pressing Enter key.



Select the corresponding axis for referencing.

Blinking zero next to selected axis will indicate that DRO is now waiting for the encoder reference mark. Move the machine to select the reference mark.

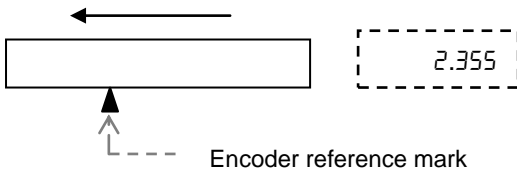

After crossing reference mark DRO will start counting. Your reference is now set.

 **Note:** It is highly recommended to mark an indicator on the encoder so as to use the same reference mark while finding the datum point.

7.7.2. Machine Reference function

Machine referencing is used when datum is not at the reference mark on encoder but at a fixed distance from reference mark.

7.7.2.1. Setting of Machine Reference

Before setting the machine reference, make sure to perform reference point function as discussed in [Section 7.7.1](#)

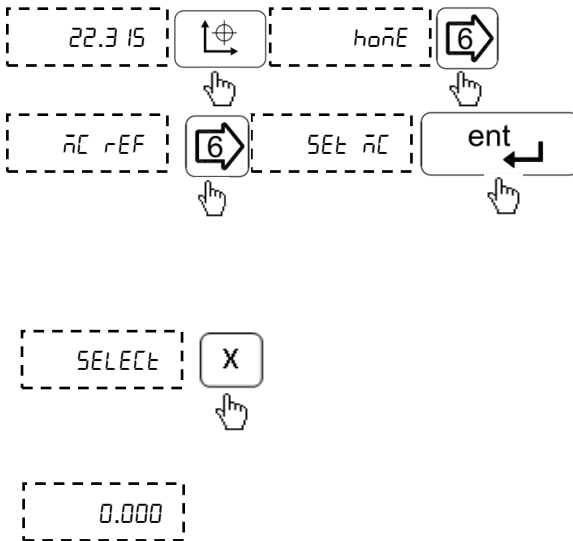

Move the machine to the required machine reference position. Then navigate with left/right arrow key to Set Machine Reference menu and press Enter to confirm the position.

Select the axis for which machine reference is to be set.

Now display will show zero on selected axis. This indicates that selected point is set as machine reference for that axis.

 **Note:** In machine reference function, the absolute datum is at a fixed distance from the reference mark of an encoder. It is marked permanently on the machine

7.7.2.2. Recall Machine Reference

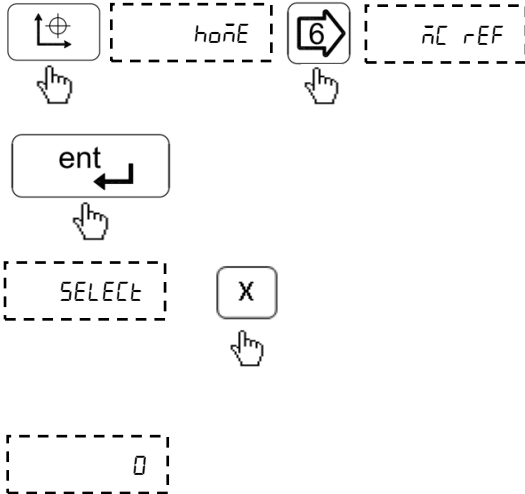

Select reference mode and navigate using left / right arrow keys to machine reference menu. Confirm with enter key.

Select axis for which machine reference is to be recalled.

Blinking zero next to selected axis will indicate that DRO is now ready to set reference. Move slide towards reference mark indicator.

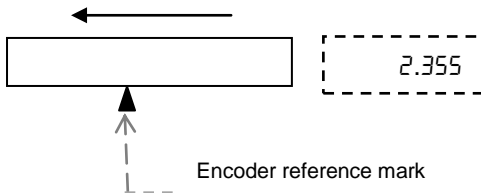

After crossing reference mark on encoder DRO will start counting.

This indicates that machine reference is now recalled.

8. Secondary Functions

8.1. Preset

Preset function allows user to set ‘Distance-to-Go’ to reach the next position. Preset function also includes Near Zero Warning function (see [Section 8.3](#)).

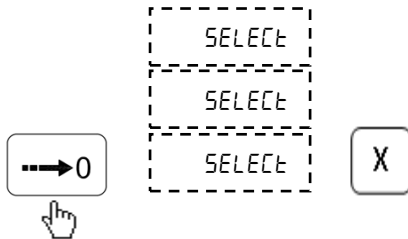

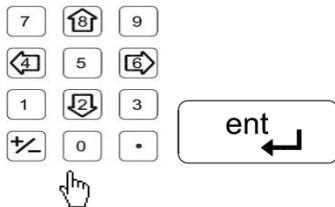

Press  key and then select the axis key.

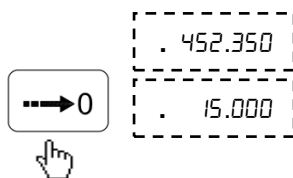

Input the numeric value and press Enter to confirm.

Repeat above steps for remaining axis.



Press  key again to execute the function.

Display will show **“Distance-to-Go”**.

 **Note:** During preset mode display works only into incremental mode and thus the datum is not disturbed.

 This function also provides near zero warning alarm (see [Section 8.3](#)).

8.2. Sub Datum Memory (SDM)

This function allows the DRO to store up to 1000 sub datum points. Each sub datum stores coordinates for all 3 axes (X, Y, and Z). In operation, the datum of the machine is replaced by each sub datum in turn, allowing the operator to work to zero for each sub datum instead of having to constantly refer to printed list of coordinates. SDM LED glows during working in this function

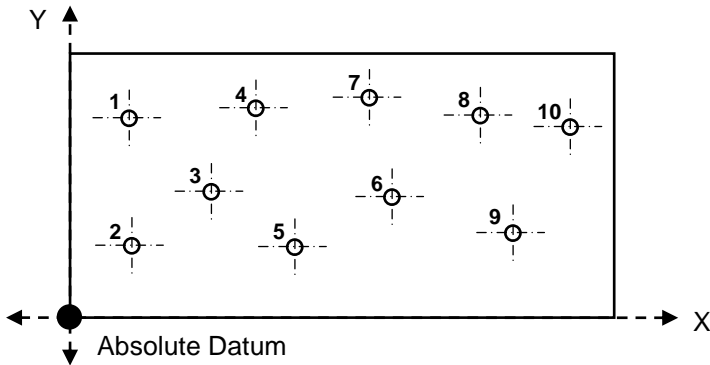

There are three options under SDMs.

8.2.1. Program mode (PrōGrAn)

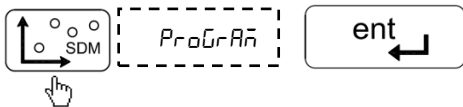

Select SDM menu and Program mode. Press enter to confirm.

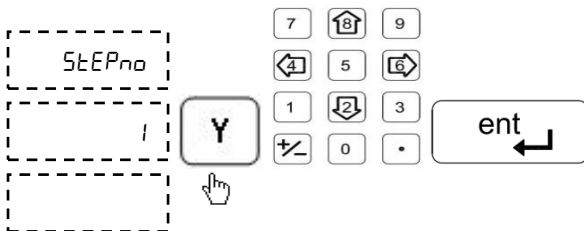

As a standard step number 1 is displayed. This can be edited by pressing **Y** axis key and entering the required step number.

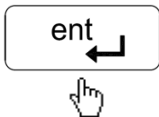
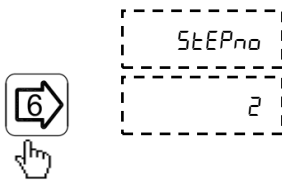
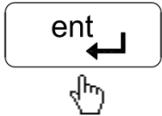
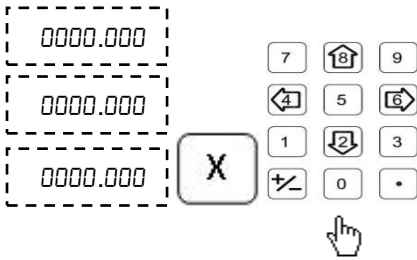

In this manner, you can enter all SDMs.

Press **C** key to exit.

Select the required axis and enter the values for the selected step. Press **ent** to confirm each value.

Press **6** key to go to next step. With right and left key user can select previous/next step. To go any step directly after pressing **6** press **Y** key and then step number which user want to go and press **ent** key.

Press **8** to see current step number Press Up arrow key again to exit.

8.2.2. Learn Mode (LEARN)

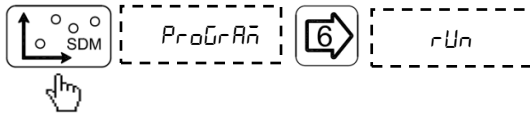

Select SDM mode and navigate to 'Learn' menu with left / right arrow key.

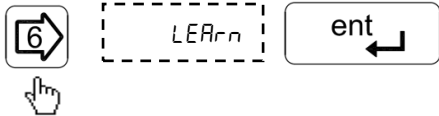

Enter the required step number on **Y** axis display. Press Enter to confirm.

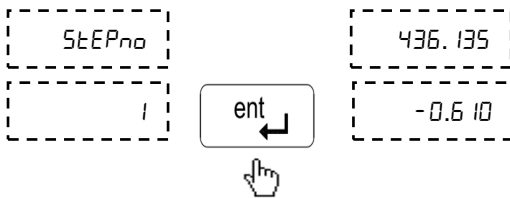

Move the machine to the position to be stored as sub datum for all axes and press **6**. This will show the current step number. By pressing the **6** again will store the position and go to the next step.

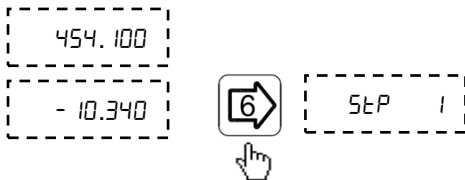

Use above steps to complete all required locations. Maximum 1000 steps can be stored.

Press **C** key to exit.

8.2.3. Run Mode (rUn)

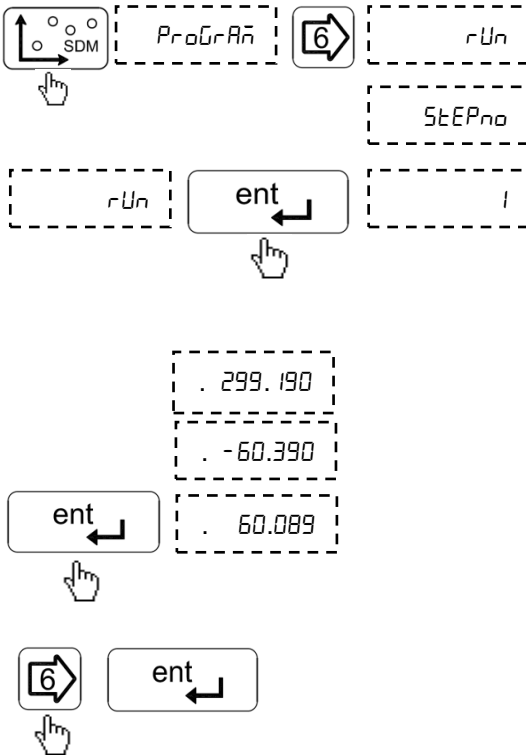

After selecting SDM mode Select run program from program menu with navigation.

In run menu display will show step number one. Enter the required step number by pressing **Y** and with numeric values. Press **ent** to confirm.

Pressing **ent** will display distance to go for the selected step no.

Press **6** key to go to next step.



This can be repeated for all the step nos.

Press **C** key to exit.

8.3. Near Zero Warning

EL 400 DRO features a unique Near Zero Warning function which alerts user once the machine position is within 50 microns of the set value.

This function is automatically enabled in the following functions:

-  Preset function
-  Sub Datum Memory (SDM)
-  All milling specific functions.

8.4. Center Of Circle

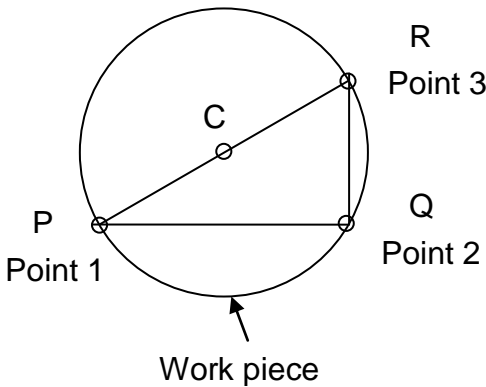

Center Of Circle function allows user to find center of a circle by locating three points on the circle.

Distance to the center from current location is shown on DRO display as **Distance-to-go**.

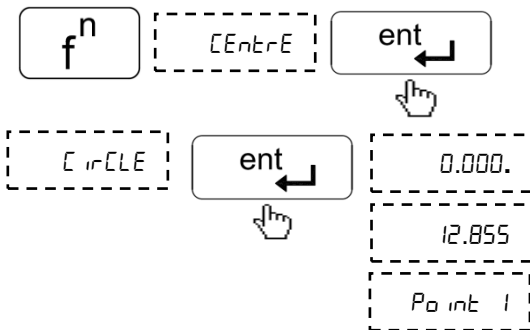

Press function key to select Center of Circle menu, press enter key to confirm.

While in this function Fn LED will glow

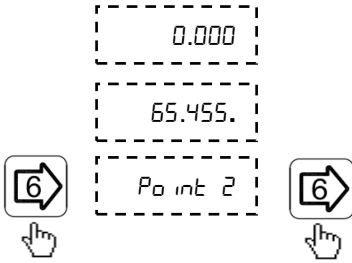

Move to first point on circle.

Pressing will store value.

Repeat this step for remaining points.

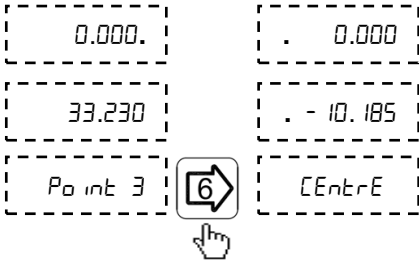

After storing all three points press to display **Distance-to-go** to center of circle.

8.5. Center Of Line

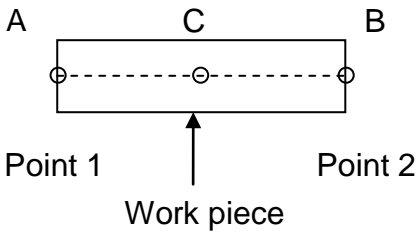

Center Of Line function allows user to find center of a line by locating end points of the line.

Distance to the center from current location is shown on DRO display as **Distance-to-go**.

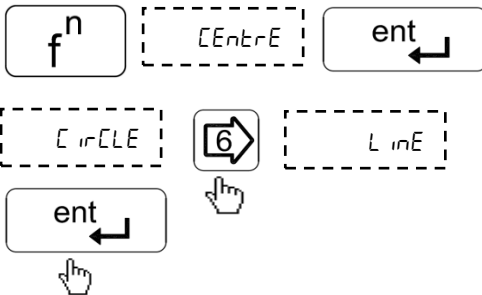

Enter Center of Line menu

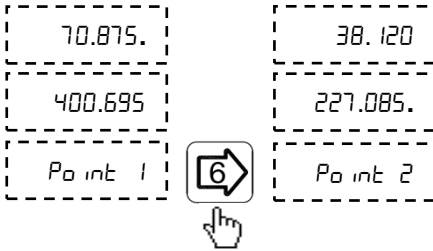

Move to first point on line.

Pressing  will store value.

Repeat this step for second point.

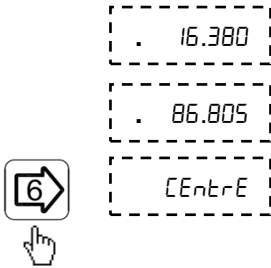

After storing both points pressing  will display **Distance-to-go** to center of line.

9. Machine Specific Functions

9.1. Milling Machine Specific Functions

9.1.1. Circular Bolt Hole Function (PCD)

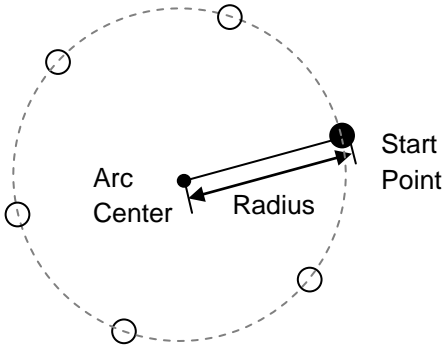

Circular Bolt-Hole function (also known as PCD) allows user to generate a pattern of holes along the perimeter of circle. After taking data from user such as co-ordinates of centre, radius, starting angle and number of holes, the table of required points is automatically generated and user is shown distance required to travel to each hole.

9.1.1.1. Procedure

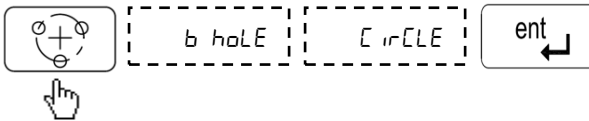

Enter Bolt-Hole function.

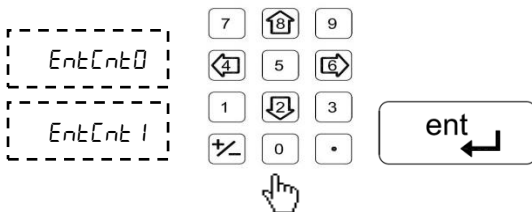

Enter **X** (ENTCNT0) and **Y** (ENTCNT1) axis **co-ordinates of Centre** of circle.

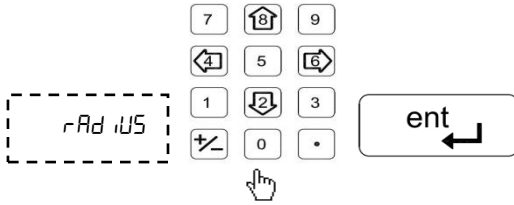

Enter **radius of circle**.

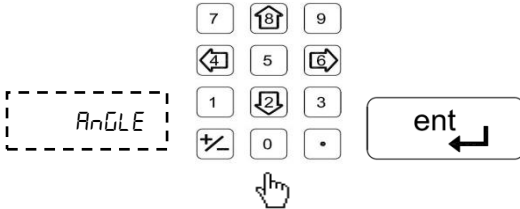

Enter **starting angle** this angle is with positive X-axis.

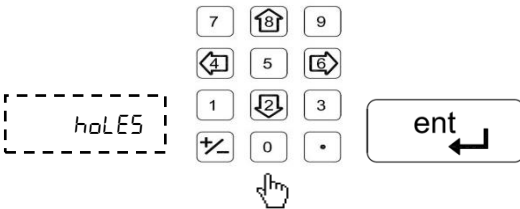
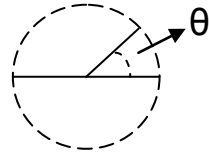

Enter total **number of holes**.

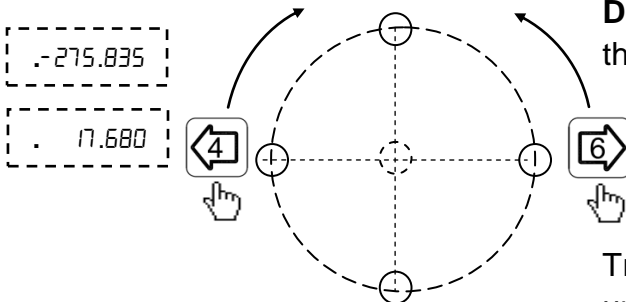

DRO will display the **Distance-to-Go** to the first hole.

Traverse X and Y axes until display value are zero.

9.1.1.2. Additional Options Available

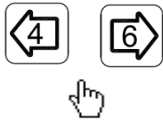

Press or key to know **Distance-to-Go** for each point. Continue to drill the remaining holes in the same way.



Press key to see **current hole number**. Press it again to exit.

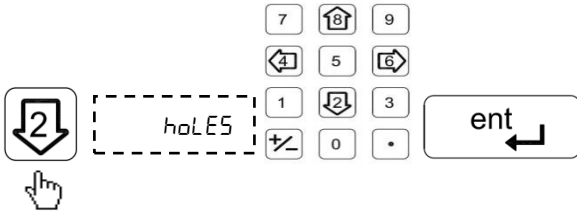

Press key to **select the specific hole.**

Press key to exit the function.

9.1.2. Arc Bolt Hole Function

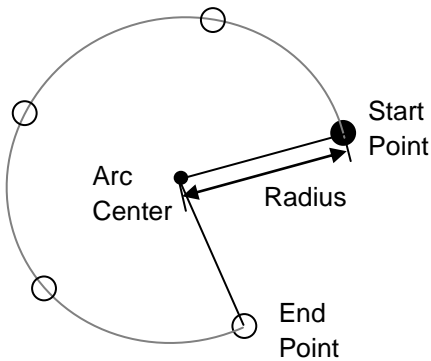

Arc Bolt Hole function is very similar to Circular Bolt Hole function, except in arc hole function user can enter the starting and ending angle of an arc. This angle is always with respect to positive X-axis and is calculated in anti-clockwise direction.

9.1.2.1. Procedure

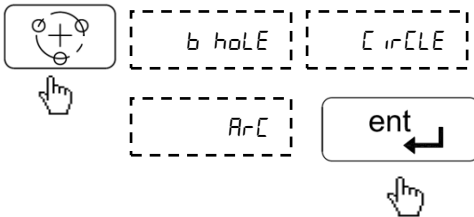

Enter Arc Bolt-Hole function.

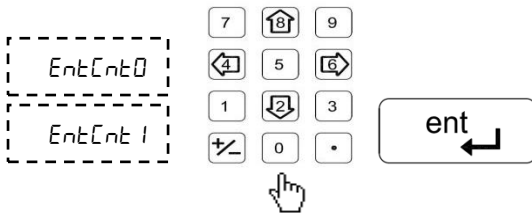

Enter X (ENTCNT0) and Y (ENTCNT1) axis **co-ordinates** of **Centre** of arc.

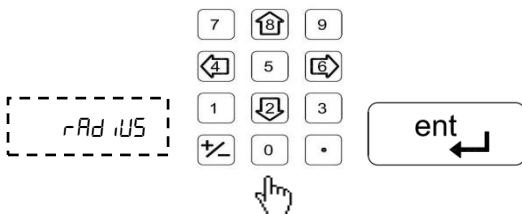

Enter **radius of arc**.

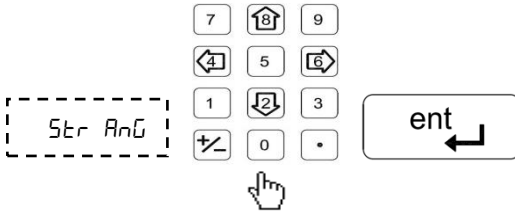

Enter **starting angle**.

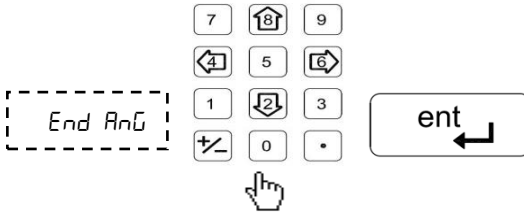

Enter **ending angle**.

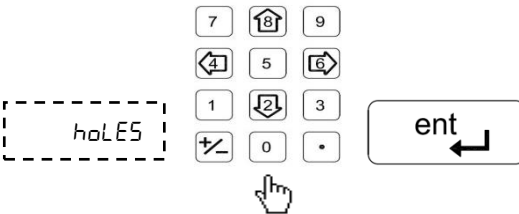

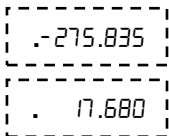

Enter total **number of holes**.

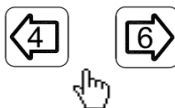

DRO will display **Distance-to-Go** for the first hole.

9.1.2.2. Additional Options Available





Press  or  key to **cycle through Distance-to-Go** for each point.

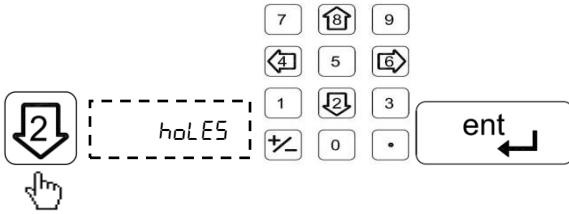

Press  to **see current hole number**
Press Up arrow key again to exit.



Press  key to **jump to specific hole.**

Press  key to exit this function.

9.1.3. Arc Contouring Function

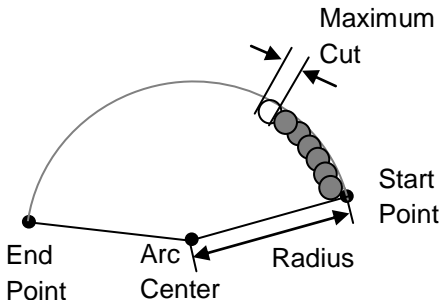

This function calculates the positions of points along the line of the arc using the required parameters.

9.1.3.1. Procedure

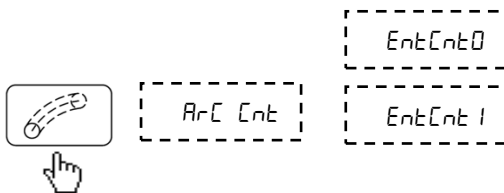

Enter arc contouring function.

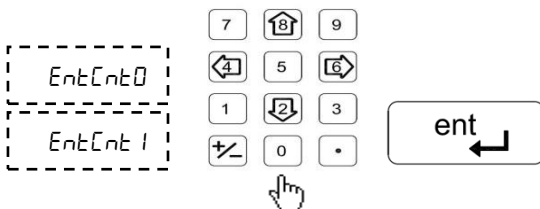

Enter **X** (ENTCNT0) and **Y** (ENTCNT1) axis **co-ordinates of Centre** of arc.

rAd iUS

7		9
	5	
1		3
	0	.

ent

Enter **radius of arc**.

Str AnG

7		9
	5	
1		3
	0	.

ent

Enter **starting angle**.

End AnG

7		9
	5	
1		3
	0	.

ent

Enter **ending angle**.

tool di

7		9
	5	
1		3
	0	.

ent

Enter **tool diameter**.

int CUT

Ext CUT

Select type of cut i.e. internal cut, external cut or mid cut. Right toggle key will cycle through all available options.

Mid CUT

ent

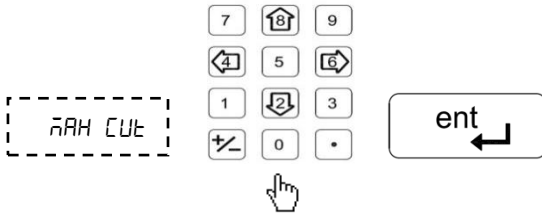

Enter Maximum cut or step size.

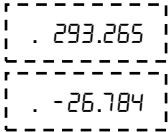

DRO will display **Distance-to-Go** till first hole.

9.1.3.2. Additional Options Available

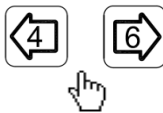

Press or key to **cycle through Distance-to-Go** for each step.



Press key to see current **hole number**. Press Up arrow key again to exit.



Press key to **jump to specific hole**.

DRO will display **Distance-to-Go** till first hole

Press key to exit this function.

9.1.4. Angle Hole Function

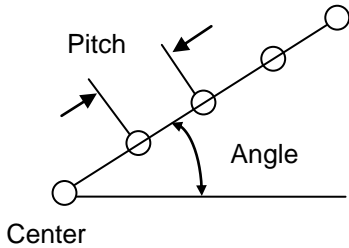

This function calculates the position of the holes on a line with the help of parameters such as starting point, pitch angle of a line and no. of holes.

9.1.4.1. Procedure

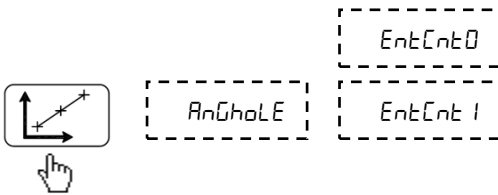

Enter Angle Hole function.

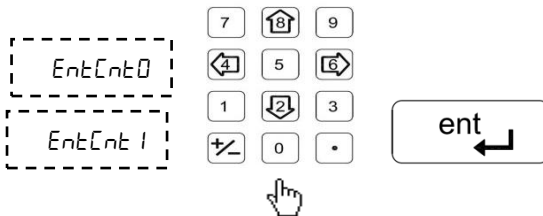

Enter **X** (ENTCNT0) and **Y** (ENTCNT1) axis **co-ordinates**. Starting point of a line.

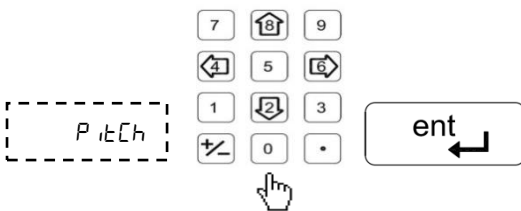

Enter **pitch** between two holes.

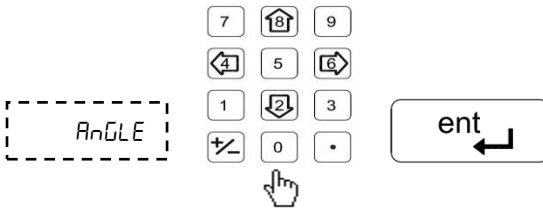

Enter **angle of line** with positive X axis between two holes.

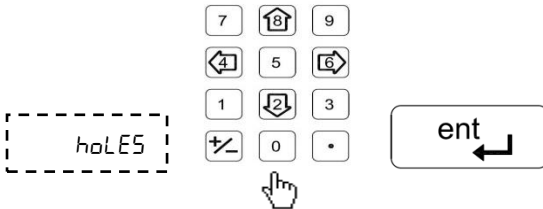

Enter total **number of holes**.

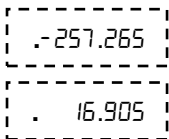

DRO will display **Distance-to-Go** till first hole.

9.1.4.2. Additional Options Available



Press **←** or **→** key to **cycle through Distance-to-Go** for each step.



Press **⌂** key to see current **hole number**. Press it again to exit.



Press **↵** key to **jump to specific step**.

9.1.5. Grid Function

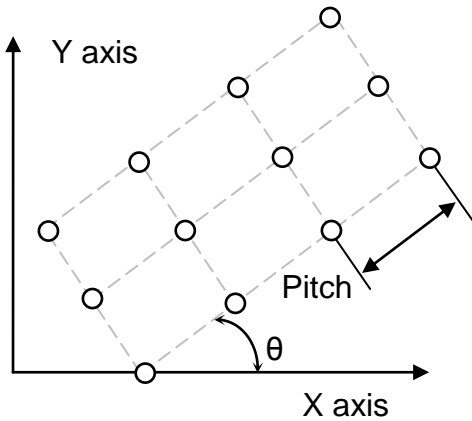

The grid function calculates the locations of the holes of pattern in XY plane. This pattern can be at a tilt angle from X axis. The calculations are done with parameters like starting point co-ordinates, holes spacing, tilting angle of the line and number of holes.

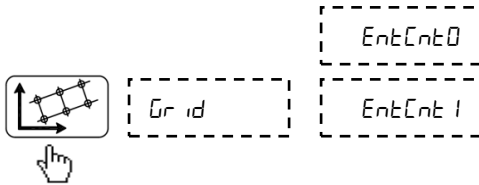

Enter **Grid** function.

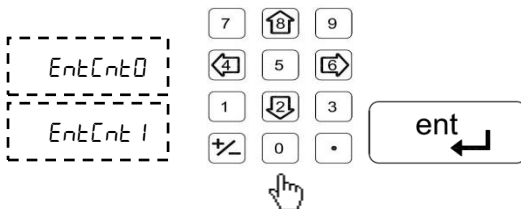

Enter **X** (ENTCNT0) and **Y** (ENTCNT1) axis **co-ordinates** Starting point of Grid.

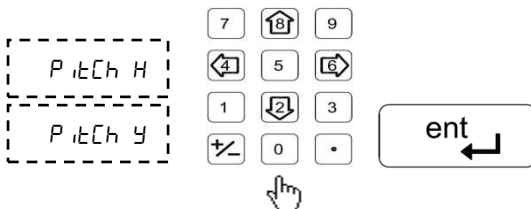

Enter distance between two holes for X axis and for Y axis. (Pitch X & Pitch Y)

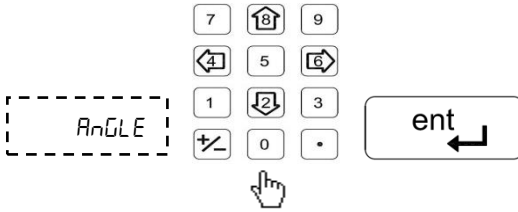

Enter **angle of grid** with positive X axis between two holes.

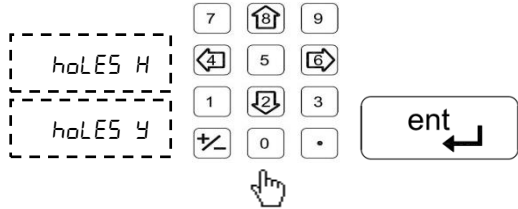

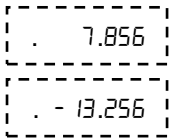

Enter total **number of holes** for X axis and Y axis.



DRO will display **Distance-to-Go** till first hole.

9.1.5.1. Additional Options Available



Press  or  key to **cycle through Distance-to-Go** for each step.



Press  key to see current **hole number**. Press it again to exit.

9.1.6. Linear Bolt Hole

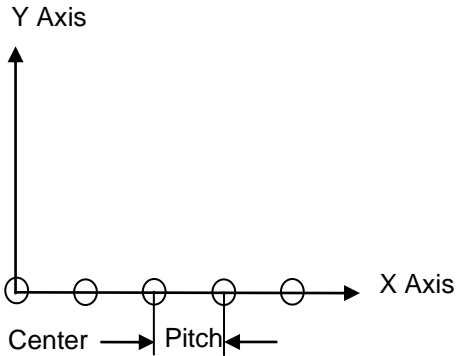

Linear Bolt Hole function allows user to create an equality spaced pattern of holes in linear direction. After taking data from user such as axis and pitch, the table of required points is automatically generated and user is shown distance required to travel to reach particular hole.

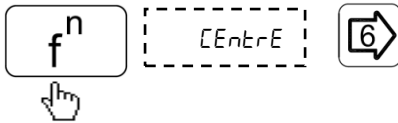

Enter Linear Bolt Hole menu.

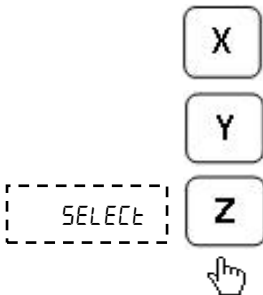

Select axis along which Linear Bolt Hole pattern is to be generated.

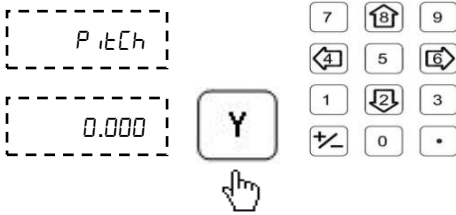

Reset axis by pressing axis key. Enter the required pitch and press  to confirm value.

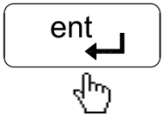

Pressing  again will return DRO to counting mode and **Distance-to-go** will be displayed till first hole.



After reaching first hole pressing  will show **Distance-to-go** till next hole.



9.1.7. Polar Co-ordinates

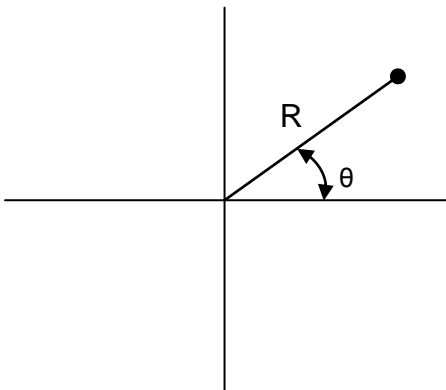

Polar Co-ordinates function allows user to measure distance in Polar Co-ordinate measuring system.

Here one axis is used to display radius (**R**) and other is used to display angle (**θ**) as shown in table below.

If user wants to set axis value, it should be perform prior entry in this function.

Plane	Radius (R)	Angle (θ)
X - Y	X Axis	Y Axis
X - Z	X Axis	Z Axis
Y - Z	Y Axis	Z Axis

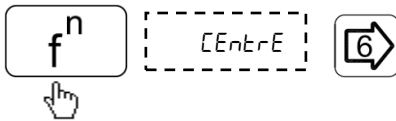

Enter Polar Co-ordinates menu.

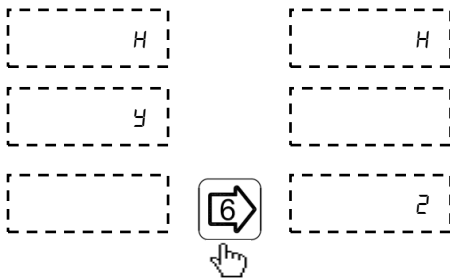
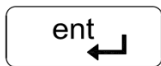

Select the desired Plane. Pressing  will cycle through available Plane options.

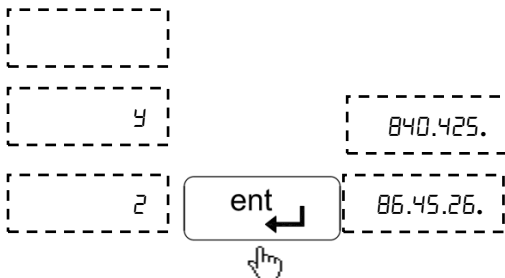

Press  key

DRO will return to counting mode.

9.1.8. Axes Summing

This function allows displaying the sum Z and U axes. Thus the function is applicable only for 4 axes mill version DRO.

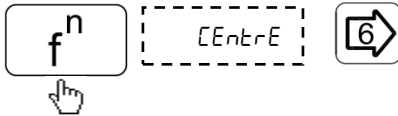

Select Axes Summing menu.

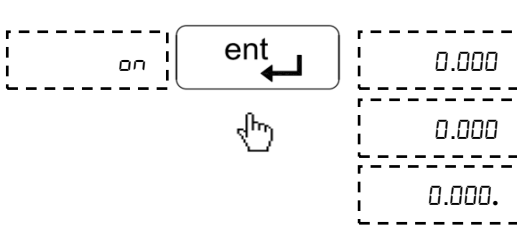
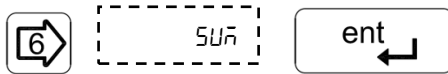

Pressing  will automatically switch ON the axes summing function.

Pressing  will switch off Axes Summing Function.

9.2. Lathe Machine Specific Functions

9.2.1. Tool Offset

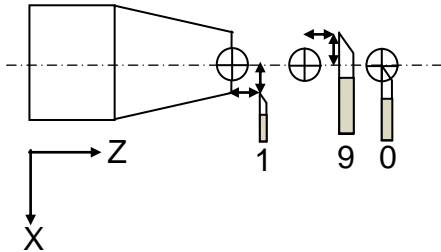

Tools differ in length as well as in diameter, making compensation in slide movement necessary to accommodate the dimensional variation of the tools. This compensation is known as the tool offset. Once the tool offset is established, the slide movement is automatically adjusted according to the value that is set. EL 400 series DRO supports 9 such tool offsets. While in this mode DRO operates in ABS mode.

There are two options under Tool Offsets

9.2.1.1. Tool Offset Program Mode

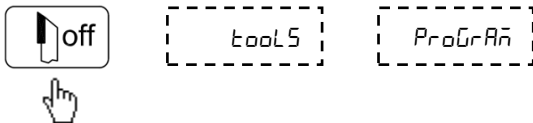

Enter Tool Offset Mode and press Enter key to confirm mode.

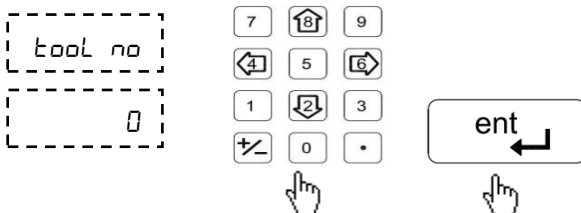
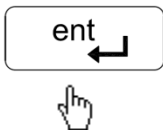

Enter Tool number.

Take the slim cut along outside diameter of the part or touch the tool to the surface of the part (if cylindrical)

Move the tool away from the part without disturbing X-axis and measure the Diameter of the part

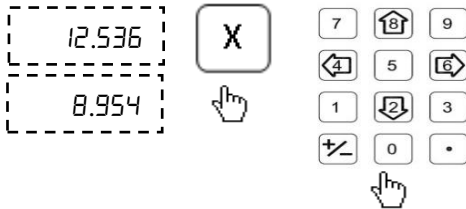

Press X axis key and enter Diameter of the part and press Enter.

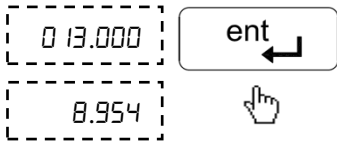

Take the facing cut or touch the end of the part with the tool. Move the tool away from the part, without moving the Z axis.

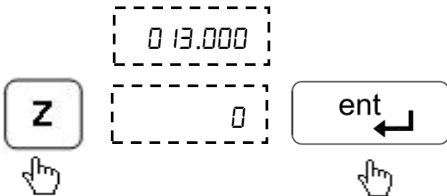

Press Z axis key and press Enter to zero the axis.

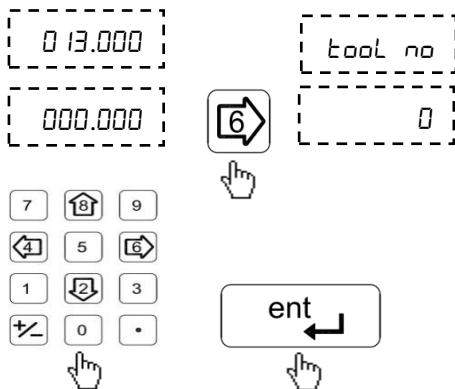

Now Tool Offset Datum is established.

Press Left arrow key to move next tool offset calculations.

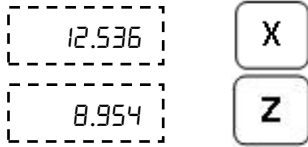

Follow above procedure for setting tool offset for the remaining tools.

9.2.1.2. Tool Offset Run Mode

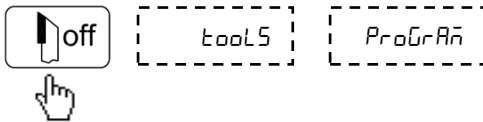

Enter tool offset function and press Right arrow key to select Run mode.

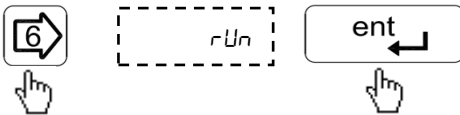

Press Enter key to confirm the mode.

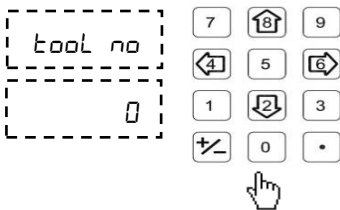

Enter Tool number and press Enter key.

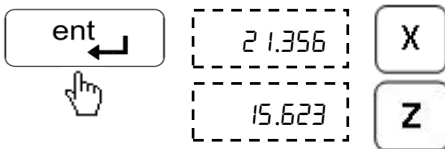

Now display shows last reading changed while tool offset calculation plus tool offset value of the entered tool number.

Press **C** key to exit from Tool offset mode.

This is a mode in which you can execute other functions like Taper, Addition, Vector, Steps, Half, etc.

9.2.1.3. Additional Options available in Run Mode

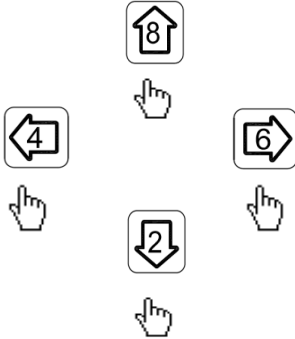

In tools Run Mode menu, left and right arrow keys can be used to select different tool offsets.

Press key to see current tool number Press Enter key to exit.

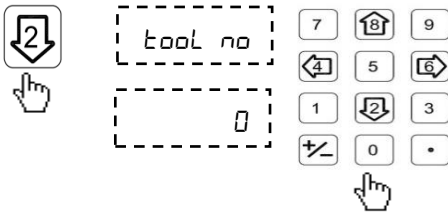

In tools Run mode menu using key new tools offset value can be enter by numeric keys

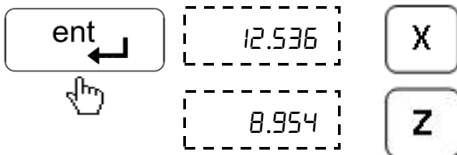

Press Enter key to confirm Tool No.

Now display shows last reading changed while tool offset calculation plus tool offset value of the selected tool no.

9.2.2. Taper Function

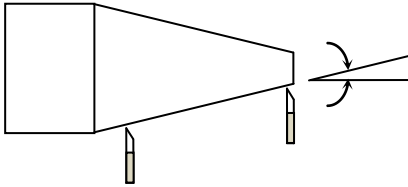

Taper function allows user to calculate taper of the job. Measurements carried out in Taper function are Radius of taper and Angle θ° of taper. Taper on axis setting is available in DRO setup menu. This will select where to display taper angle. See [Section 6.2](#).

9.2.2.1. Procedure

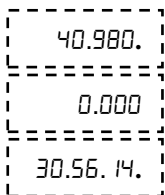
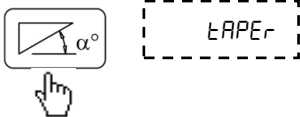

Touch the tool to one end of the taper and reset X and Z axis.

Enter Taper Function.

Now move the tool to the other end of the taper. Taper angle is displayed on DRO display.

Following table illustrates Radius and Angle display relation

Taper ON axis	Radius (R)	Angle (θ°)
X axis	Z axis	X axis
Z axis	X axis	Z axis
Z' axis	X axis	Z' axis

9.2.3. Axes Addition Function

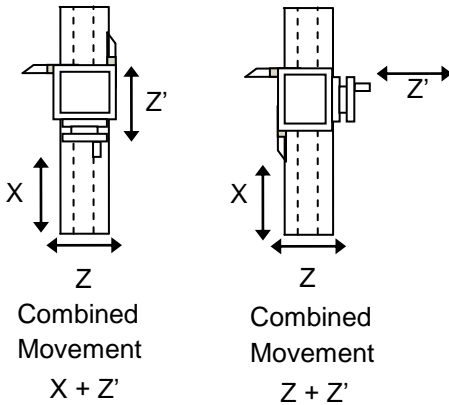

Axes Summing function is used to display combined movement of either $X - Z'$ axes pair or $Z - Z'$ axes pair. The summing axis pair can be displayed either on X axis or Z axis. Summing pair axis configuration setting is available in DRO setup menu. See [Section 6.2](#)

9.2.3.1. Procedure

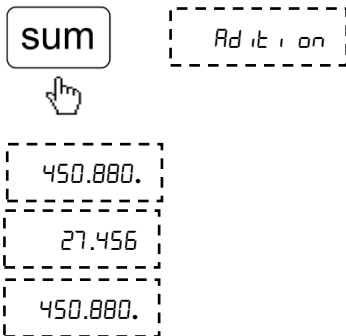

Enter Summing pair function.

Summing pair result is displayed on DRO display.

Following table illustrates Summing axis pair and result display axis relation.

Summing axis pair	Combined movement displayed on axis
X axis & Z' axis	X display
Z axis & Z' axis	Z display

9.2.4. Vectoring Function

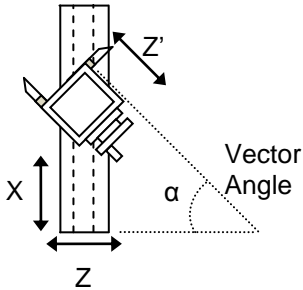

Combined Movement X = X + Z' (Sin α)
 Combined Movement Z = Z + Z' (Cos α)

Vectoring function is used for displaying combined movement of either X – Z' axis pair or Z – Z' axis pair taking into consideration angle between Z and Z' i.e. α. The resulting combined movement is displayed on X and Z axis.

9.2.4.1. Procedure

Select Vectoring function

Enter angle between Z and Z' axis.

Resulting combined movement will be shown on DRO display.

Following table illustrates combined movement and display relation

Combined Axis Movement	Combined Movement displayed on
X + Z' (Sin α)	X display
Z + Z' (Cos α)	Z display

9.3. EDM Machine Specific Functions

9.3.1. Circular Bolt Hole Function

See [Section 9.1.1](#)

9.3.2. Arc Bolt Hole Function

For EDM machine specific DRO a dedicated key  is provided for this function. For more details see [Section 9.1.2](#).

9.3.3. Angle Hole Function

See [Section 9.1.4](#)

9.3.4. Pre-Set Depth (PSD) Function

PSD feature is used to control relay at a pre-set depth setting. This feature is widely used in Electric discharge machines (EDM) where sparking process has to be stopped after reaching the required preset depth value.

This feature is available only for Z-axis in case of 3 axes DRO and on X axis in case of 1 Axis DRO.

PSD is also sometimes referred as Single Output function.

9.3.4.1. Setting for Time Delay

There are six pre-defined delay settings available which can be set as follows

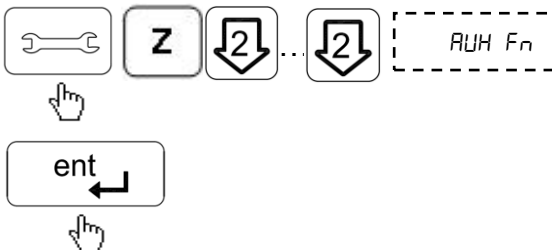

Enter Auxiliary setup menu.

Note that this option is available only on Z axis for 3 axes DRO and on X axis in case of 1 axis DRO.

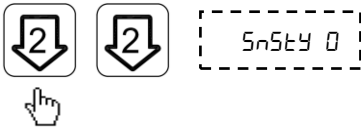

Select time delay by using left and right keys.

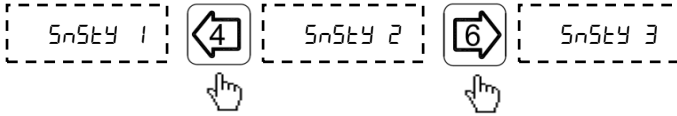

Sensitivity Count	Time Delay in seconds In mm mode	Time Delay in seconds In Inch mode
SNSTY0 (SnStY 0)	0.000	0.000
SNSTY1 (SnStY 1)	0.118	0.210
SNSTY2 (SnStY 2)	0.236	0.420
SNSTY3 (SnStY 3)	0.354	0.630
SNSTY4 (SnStY 4)	0.472	0.840
SNSTY5 (SnStY 5)	0.590	1.050

60



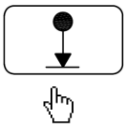
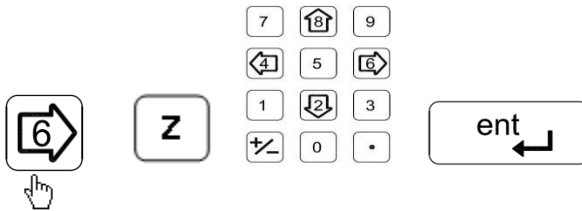

9.3.4.2. Using PSD Function

Select PSD function, Enter preset depth for z-axis.

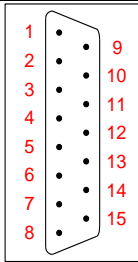

9.3.4.3. Pin Connection Details (V10):

Pin No.	Description		Pin No.	Description
1	Relay NC		9	Relay NC
2	Relay Pole		10	Relay Pole
3	Relay NO		11	Relay NO
4	-		12	-
5	-		13	-
6	Ext. SW +		14	-
7	-		15	Ext. SW -
8	-		-	-

-  The external switch (Pin no. 6 and 15) has the same functionality as  key on keyboard.
-  Relay contact ratings: 24 V at 2A current maximum.
-  PSD ON will activate the relay connecting the Relay NO and Pole.

10. Auxiliary Functions

10.1. Touch Probe Functions

Touch probe also called as Contact probe is a device which gives a trigger signal when it comes in contact with the work-piece. The EL 400 DRO uses this trigger signal to execute certain functions which helps the operator to set an axis or measure a work-piece.

Probe functions are categorized into following categories:



10.1.1. Basic Settings:

 **DRO Type:** The DRO can be configured as “DRO T” and “DRO F” in setup mode. The “DRO T” mode flashes the probe message on trigger. And the “DRO F” freezes the coordinates on trigger.



Enter Auxiliary setup menu.



Toggle using  key and  key.

 **Probe Delay:** This delay is provided to avoid multiple probe trigger during measurement. The user can set value between 1 second to 60 seconds.

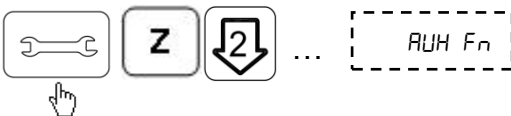

Enter Auxiliary setup menu.



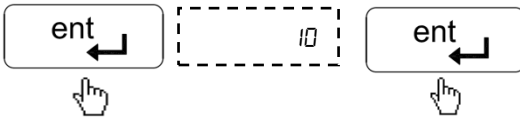

Previous delay value is displayed.

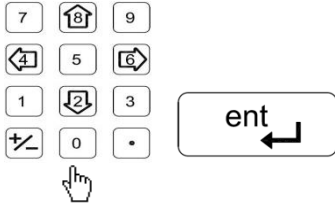

Enter new delay.

 Probe Diameter and length: Before using the other probe functions make sure that the probe diameter and length are entered.

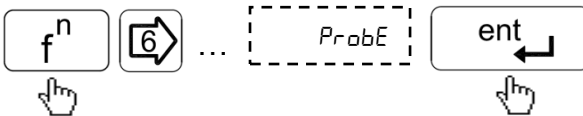

Select Probe menu.

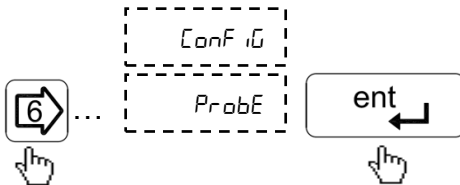

Enter Probe configuration menu.

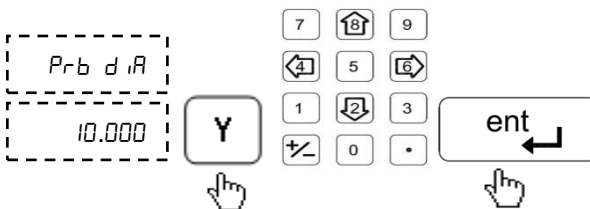

Enter Probe diameter.

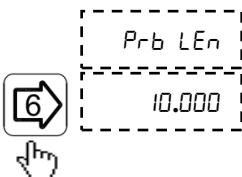

Probe Length message.

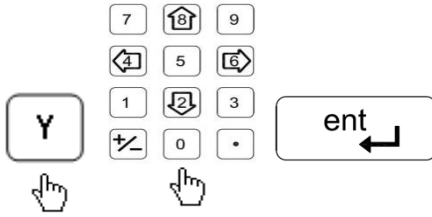

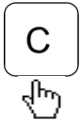

Enter Probe Length.



Press **C** key to come to normal counting mode.

10.1.2. Special Probe Functions:

-  Datum Function: The co-ordinates of the datum can be set by probing edges or surfaces and capturing them as datum.
-  Datum by edge: Here the DRO sets the datum at the trigger edge of the work piece.

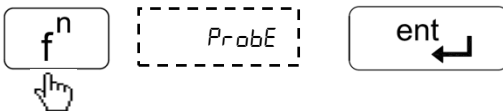
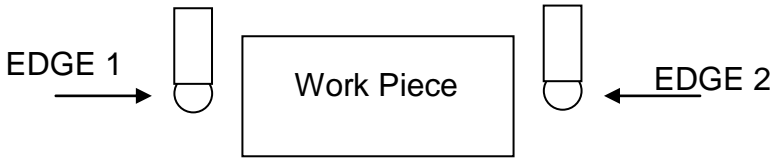

Select Probe menu.

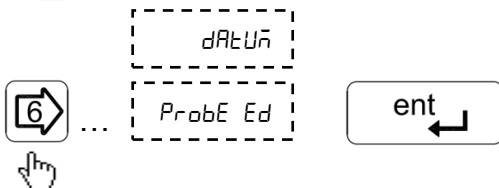

Select the Probe Edge datum menu.

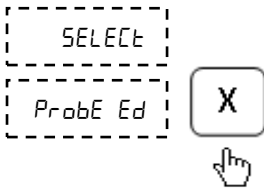

Select axis for the Datum.

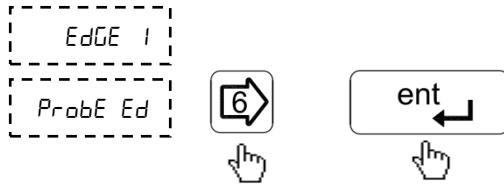

Toggle between Edge 1 and 2 and execute function.

The DRO receives the trigger pulse form the probe and sets the datum accordingly. (After the trigger pulse the DRO waits for the user to set the axis at the datum point) When the trigger pulse is sensed user can enter the desired co-ordinates of the datum.

 Datum by midpoint: Here the DRO sets the datum at the midpoint of the two work piece edges.

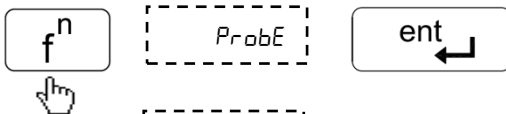
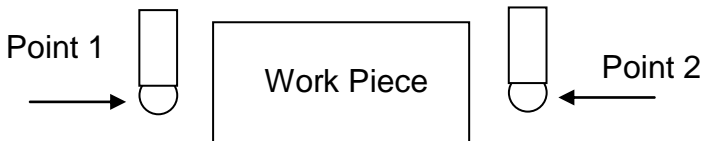

Select Probe menu.

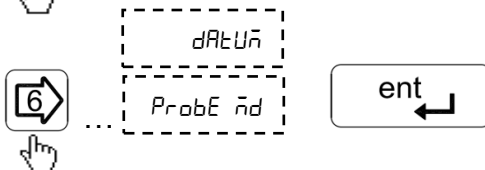

Select Probe Midpoint datum menu.

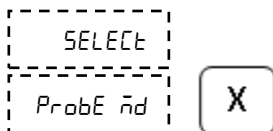

Select axis for the Datum.

Move the probe towards work piece edge 1 till the DRO receives first trigger pulse. Move the probe towards work piece edge 2 till the DRO receives second trigger pulse. Enter the co-ordinates of the midpoint as datum on selected axis.

 **Inside / Outside Measurement:** This function is used to measure work piece center and width.

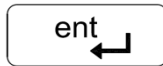
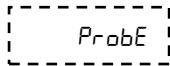
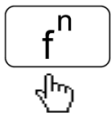
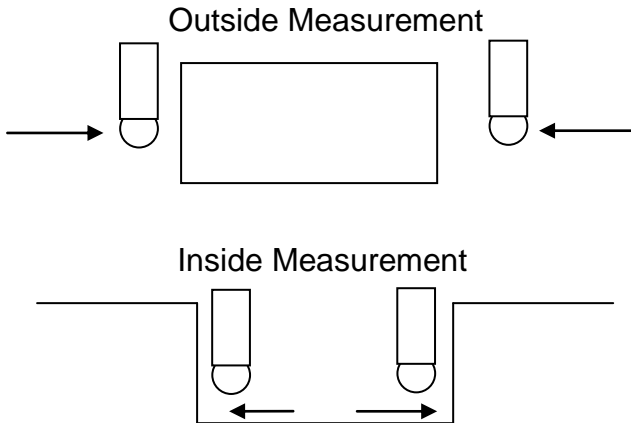

Select Probe menu.

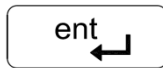
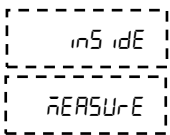

Select inside or outside measurement option.

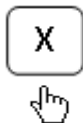
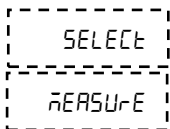

Select axis for measurement.

Move the probe towards work piece edge 1 till the DRO receives first trigger pulse. Move the probe towards work piece edge 2 till the DRO receives second trigger pulses. The display shows coordinates of the center and width of the work piece on the selected axis.

10.2. Six Output Functions



There are six optically isolated outputs.

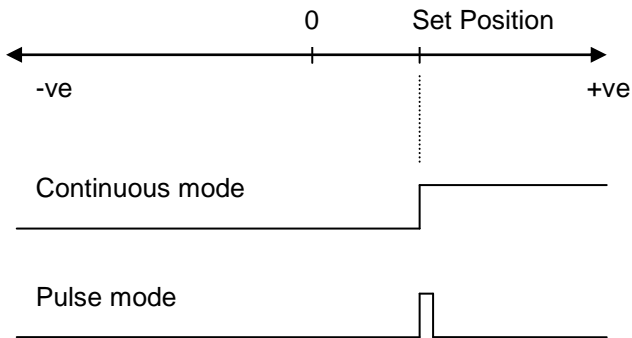

User entered position for six outputs are stored in DRO; however at any point of operation user has flexibility to edit values using Program function.

In continuous mode if current tool position is greater than the entered value then respective output remains high, and when it is less the corresponding output remains low. However in case of pulse mode, only pulse is obtained whenever tool passes the set position in either direction.

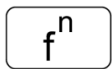

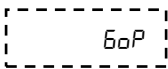
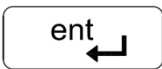

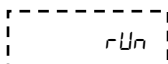

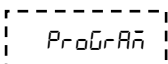
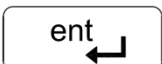
10.2.1. Program Six Output (P_{rogrAn})

     Enter Six Output menu.

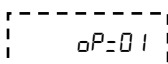
    Enter program menu.

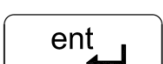

    Select total number of outputs using left and right key.



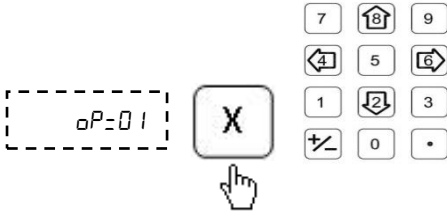

Enter position for each output at the respective axis.

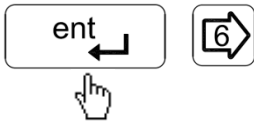

Repeat this step for all outputs.

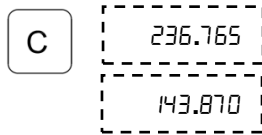

Press cancel key to exit to DRO display screen.

10.2.2. Execute Six Output (rUn)

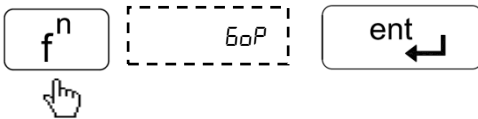

Program runs as per positions specified by user.

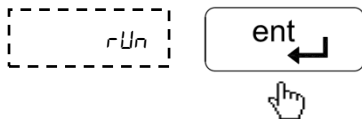

The decimal point on the last digit of the axis indicates that the “six output” is active for that axis.

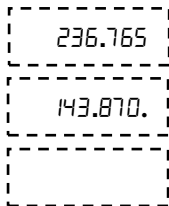

10.2.3. Pin Connections

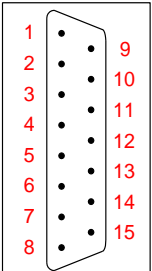
Pin No.	Description		Pin No.	Description
1	Ext. +24V		9	O/P 1
2	O/P 2		10	O/P 3
3	O/P 4		11	O/P 5
4	O/P 6		12	Ext. GND
5	-		13	-
6	-		14	-
7	-		15	-
8	-		-	-

Electrical Output specifications:

- Outputs are open collector.
- Maximum current rating 500mA max.
- Output voltage rating 24V max.

For testing output of the function make the use of external components with connector as shown in figure below

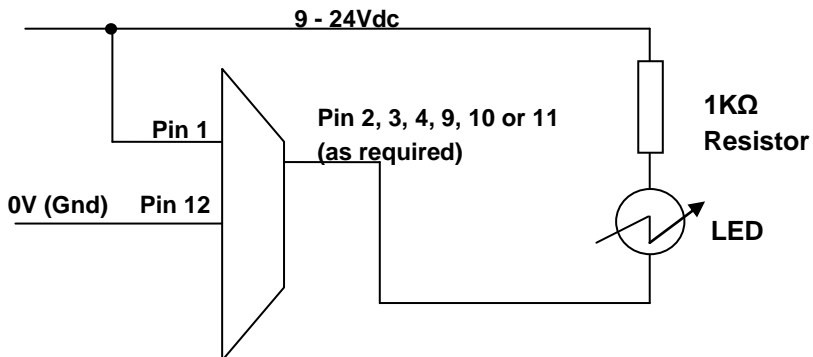

 **Note: “Six output” function is not available in EDM version DRO.**

10.3. Serial Communication Functions

EL 400 allows two modes of serial communication continuous mode and on request transfer. In continuous mode the current displayed counts are transmitted to PC and can be viewed on windows Hyper Terminal Software.

The Following results are shown on Terminal screen.

0010.005 ARMX 0086.980 ARMY 0000.000 ARMZ

Symbol	Meaning
A	Absolute readings
I	Incremental
R	Radial
D	Diametric
X/Y/Z	Axes
M	MM
N	Inch

The Hyper Terminal Settings should be as under

Setting options	Values
Communication port	Com1 / Com2
Baud rate /Bits Per second	9600

Date Bits	8
Parity	None
Stop bits	1
Flow Control	None





On request mode the current displayed counts are transferred to PC by pressing  key and can be viewed with EL300 PC Side Utility software (Refer Software Utility Guide for details). If there is a communication error between DRO and PC, DRO displays “Pc fail” message.

Press  key to exit the function.

11. Troubleshooting

11.1. Self Diagnostics Mode

EL 400 DRO features self diagnostics mode which checks for following areas.

-  Memory corruption
-  Display function
-  Keyboard functioning
-  Encoder diagnostics

Self diagnostics mode is enabled by pressing  during startup message. First it will enter in memory diagnostic mode.

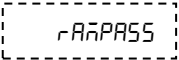
If no fault is found in memory the display will show 

Press any key to stop display diagnostic and proceed with keyboard diagnostic. Here DRO will display the pressed key.

Press  key once to exit any diagnostic mode.

To exit Self diagnostics mode press  key twice.

11.2. Troubleshooting Guidelines

Problem Observed	Guidelines
No display / Display glows momentarily	<ul style="list-style-type: none"> • Mains supply should be <ul style="list-style-type: none"> ○ L – N : As specified ○ N – E: < 3Vrms ○ L – E : As specified • Check the fuse. Note that if the fuse has blown, this suggests a fault with the Power source which must be corrected before the fuse is replaced.
Readings are incorrect	<ul style="list-style-type: none"> • Check if encoder connections are proper. • Check calibration factor and if required recalibrate DRO. • If using segmented error compensation, verify the datum position.
The displays work, but give erratic readings, the last digit jitters or the measurements jump to new figures unexpectedly.	<ul style="list-style-type: none"> • Ensure that supply is within specified limits. • This is possible because of poor earth connection. Ensure that the DRO and the machine on which it is installed must have proper earth connection. • Ensure that cable routing is proper and away from high capacity inductive load. • Ensure that encoder armor is intact and properly routed. • Check for voltage fluctuation.
Erratic behavior of DRO	<ul style="list-style-type: none"> • Try switching DRO Off and turning it back on after 1 min. • Check if keypad is locked. • Try resetting DRO to default settings.

For any additional assistance contact your nearest service center.

12. List of Display Text

<i>VER</i>	VER	Version
<i>SELECT</i>	SELECT	Select
<i>LINEAR</i>	LINEAR	Linear measurement
<i>ANGULAR</i>	ANGULAR	Angular Measurement
<i>SC</i>	SC	Scale resolution
<i>DP</i>	DP	Display resolution
<i>RAD</i>	RAD	Radial mode
<i>DIA</i>	DIA	Diametric mode
<i>RIGHT</i>	RIGHT	Right counting direction
<i>LEFT</i>	LEFT	Left counting direction
<i>CALIB</i>	CALIB	Calibration mode
<i>LEC</i>	LEC	Linear error correction
<i>SLEC</i>	SLEC	Segmented linear error correction
<i>DISPVAL</i>	DISPVAL	Display value
<i>CAL FAC</i>	CAL FAC	Calibration factor
<i>ENF ON</i>	ENF ON	Encoder fail ON
<i>ENF OFF</i>	ENF OFF	Encoder fail OFF
<i>AUX Fn</i>	AUX Fn	Auxiliary function settings
<i>SERIAL</i>	SERIAL	Serial handshake mode
<i>SER CON</i>	SER CON	serial continues mode
<i>DRO F</i>	DRO F	DRO Freeze mode in probe sensing
<i>DRO T</i>	DRO T	DRO transmit mode in probe sensing
<i>PRB DLY</i>	PRB DLY	Probe sensing delay
<i>LOC OFF</i>	LOC OFF	Keyboard lock OFF
<i>LOC ON</i>	LOC ON	Keyboard lock ON
<i>SLEEP T</i>	SLEEP T	Sleep timer
<i>SAV CHG</i>	SAV CHG	Save changes in Set up mode
<i>RST OEM</i>	RST OEM	Reset to OEM settings
<i>OEM MOD</i>	OEM MOD	OEM mode
<i>END</i>	END	End of SET UP mode
<i>HOME</i>	HOME	Home function
<i>MC REF</i>	MC REF	Machine reference function
<i>SET MC</i>	SET MC	Set machine reference
<i>TOOLS</i>	TOOLS	Tool offset function
<i>PROGRAM</i>	PROGRAM	Program SDMs

<i>rUn</i>	RUN	Execute SDMs
<i>LEArn</i>	LEARN	Learn mode in SDMs
<i>StEPno</i>	STEPNO	Step no. in SDMs
<i>PrObE</i>	Probe	Probe function
<i>CEntRE</i>	CENTRE	Center function
<i>PolAr</i>	POLAR	Polar coordinates display
<i>SUñ</i>	SUM	Axis Summing Function in Mill
<i>6oP</i>	6OP	Auxiliary function
<i>dAtUñ</i>	DATUM	Datum setting
<i>PrOb Ed</i>	PROB ED	Probe edge option
<i>PrOb ñd</i>	PROB MD	Probe midpoint option
<i>inS idE</i>	INSIDE	inside measurement
<i>ñEASUrE</i>	MEASURE	Measurement
<i>oUtS idE</i>	OUTSIDE	Outside measurement
<i>ConF iG</i>	CONFIG	Configuration
<i>b holE</i>	B HOLE	Bolt hole function
<i>Circle</i>	CIRCLE	Circular bolt hole option
<i>ArC</i>	ARC	Arc bolt hole option
<i>EntCnt</i>	ENTCNT	Center coordinate entry
<i>rAd iUS</i>	RADIUS	Radius entry
<i>StR AnG</i>	STR ANG	Starting angle entry
<i>End AnG</i>	End ANG	End angle entry
<i>holES</i>	HOLES	No. of Holes
<i>ArC Cnt</i>	Arc CNT	Arc contouring function
<i>tool di</i>	TOOL DI	Tool diameter
<i>int CUT</i>	INT CUT	internal cut
<i>Ext CUT</i>	EXT CUT	External cut
<i>ñ id CUT</i>	MID CUT	Middle cut
<i>ñAH CUT</i>	MAX CUT	Maximum cut distance
<i>AnGholE</i>	ANGHOLE	Angle hole function
<i>P itCh</i>	PITCH	Pitch of Angle hole
<i>AnGLE</i>	ANGLE	Angle entry
<i>Gr id</i>	GRID	Grid function
<i>inVAL id</i>	INVALID	Invalid entry
<i>tAPER</i>	TAPER	Taper function
<i>Ad iton</i>	ADITON	Axis summing function in lathe
<i>vECtor</i>	VECTOR	Axis vectoring in lathe
<i>v AnGLE</i>	V ANGLE	Vector Angle
<i>Add</i>	ADD	Add in Calculator

<i>SUB</i>	SUB	Subtract in Calculator
<i>mULTI</i>	MULTI	Multiply in Calculator
<i>DIv</i>	DIV	Division in Calculator
<i>Sin</i>	Sin	Sine in Calculator
<i>CoS</i>	COS	Cosine in Calculator
<i>tAn</i>	TAN	Tan in Calculator
<i>ASin</i>	ASIN	Sine⁻¹ in Calculator
<i>ACoS</i>	ACOS	Cosine⁻¹ in Calculator
<i>AtAn</i>	ATAN	Tan⁻¹ in Calculator
<i>INF VAL</i>	INF VAL	Infinite Value
<i>RAMPASS</i>	RAMPASS	Memory ok
<i>RAMERR</i>	RAMERR	Memory error
<i>PRb DIA</i>	PRB DIA	Probe Diameter
<i>PRb LEN</i>	PRB LEN	Probe Length
<i>RSt dro</i>	RST DRO	Reset DRO
<i>HoLE no</i>	HOLE NO	Hole number
<i>LINE</i>	LINE	Line
<i>toOL no</i>	TOOL NO	Tool number
<i>no SIG</i>	NO SIG	No signal
<i>HoLE X</i>	HOLE X	Holes in X direction
<i>HoLE Y</i>	HOLE Y	Holes in Y direction
<i>PitCh X</i>	PITCH X	Pitch in X direction
<i>PitCh Y</i>	PITCH Y	Pitch in Y direction
<i>StP</i>	STP	Step
<i>EntEr</i>	ENTER	Enter
<i>CAnCEL</i>	CANCEL	Cancel
<i>F1</i>	F1	Function 1
<i>EnC_dig</i>	ENC_DIG	Encoder Diagnostic
<i>on</i>	ON	On
<i>oFF</i>	OFF	Off
<i>oPt on</i>	OPT ON	Options on
<i>oPt oFF</i>	OPT OFF	Options off
<i>t oFF</i>	T OFF	Tool offset
<i>tRy</i>	TRY	Try
<i>AGA in</i>	AGAIN	Again

13. DRO Models

Description	Ordering Code No.
EL401-S, 1 Axis Simple without Options	EL4P-11-0000
EL402-L, 2 Axes Lathe without Options	EL4L-21-0000
EL403-L, 3 Axes Lathe without Options	EL4L-31-0000
EL402-M, 2 Axes Mill without Options	EL4M-21-0000
EL403-M, 3 Axes Mill without Options	EL4M-31-0000
EL404-M, 4 Axes Mill without Options	EL4M-41-0000
EL411-S, 1 Axis Simple with Options	EL4P-11-1110
EL412-L, 2 Axes Lathe with Options	EL4L-21-1110
EL413-L, 3 Axes Lathe with Options	EL4L-31-1110
EL412-M, 2 Axes Mill with Options	EL4M-21-1110
EL413-M, 3 Axes Mill with Options	EL4M-31-1110
EL414-M, 4 Axes Mill with Options	EL4M-41-1110
EL491-E, 1 Axis EDM	EL4E-11-1000
EL493-E, 3 Axes EDM	EL4E-31-1000

Code No : 0073-14-0961
Revision Date : 22th Oct, 2010

Sales Office:
Electronica Mechatronic Systems (I) Pvt. Ltd.,
Electronica House, 2 Nursery Court,
Kibworth, Leicestershire,
LE8 0EX, United Kingdom,
Phone: +44 (0) 116 279 68 91
Fax: +44 (0) 116 279 67 02
Email: info@electronicaems.co.uk
Web: www.electronicaems.co.uk

Factory:
Electronica Mechatronic Systems (India) Pvt. Ltd.,
Unit No. 37&44, Electronic Co-operative Estate,
Pune-Satara road, Pune – 411009
Maharashtra, India
Phone: +91 (020) 2422 4440, 2422 9398,
Fax: +91 (020) 2422 1881
Email: info@electronicaems.com
Web: www.electronicaems.com

Electronica Mechatronic Systems (I) Pvt. Ltd. Is a division of Electronica Mechatronic Systems (India) Pvt. Ltd.